

# Dual 18A or Single 36A μModule Regulator with 0.8% DC and 3% Transient Accuracy

## FEATURES

- **±0.8% Maximum Total DC Output Error Over Line, Load, and Temperature (LTM4630-1A)**
- **±3% Total Output Error, Including Transients with Minimum Output Capacitance**
- Dual 18A or Single 36A Output
- 4.5V to 15V Input, 0.6V to 1.8V Output Voltage Range
- Differential Remote Sense Amplifier
- Current Mode Control/Fast Transient Response
- Current Sharing Up to 144A
- 16mm × 16mm × 5.01mm BGA Package

## APPLICATIONS

- FPGA, ASIC, μProcessor Core Voltage Regulation
- Information, Communication Systems

## DESCRIPTION

The LTM<sup>®</sup>4630-1A/LTM4630-1B are dual 18A or single 36A output step-down μModule<sup>®</sup> (power module) regulators with ±0.8% (LTM4630-1A) and ±1.5% (LTM4630-1B) total DC output error, respectively, which is very capable to achieve ±3% total output error including transients. Included in the package are the switching controller, power FETs, inductors, and all supporting components. External compensation allows for fast transient response to minimize output capacitance when powering FPGAs, ASICs, and processors. With synchronized multiphase parallel current sharing, four LTM4630-1 devices can deliver up to 144A. The LTM4630-1 is offered in a 16mm × 16mm × 5.01mm BGA package.

All registered trademarks and trademarks are the property of their respective owners. Protected by U.S. patents, including 5481178, 5705919, 5929620, 6100678, 6144194, 6177787, 6304066 and 6580258. Other patents pending.

## TYPICAL APPLICATION

36A, 1.2V Output DC/DC μModule Regulator

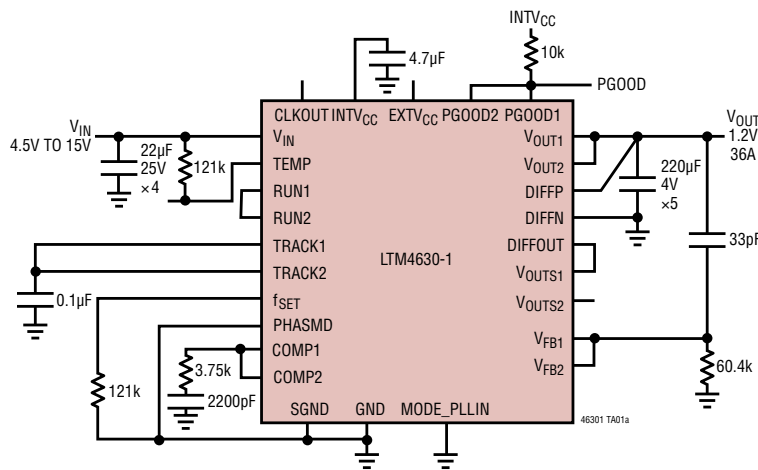

1.2V Output Efficiency vs I<sub>OUT</sub>

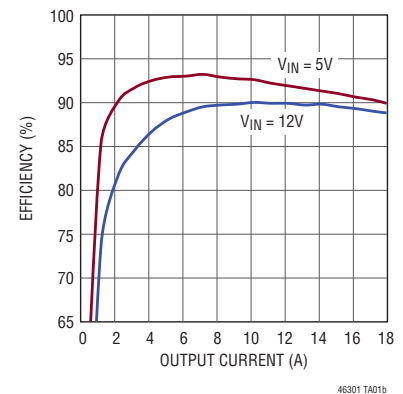

25% Load Step Transient Response, ±3% Output Regulation Window, 12V<sub>IN</sub>, 1.2V<sub>OUT</sub>, 36A with 5× 220μF Ceramic Capacitor

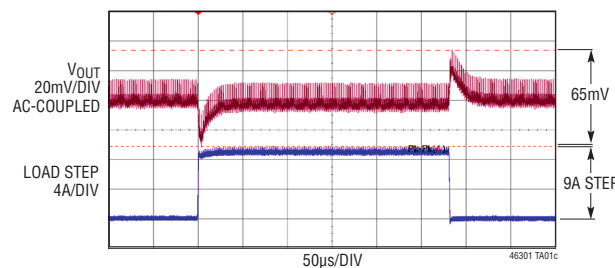

\*SEE DEMO CIRCUIT DC2081A-B

# LTM4630-1

## ABSOLUTE MAXIMUM RATINGS

(Note 1)

$V_{IN}$ .....	-0.3V to 16V
$V_{SW1}$ , $V_{SW2}$ .....	-1V to 16V
PGOOD1, PGOOD2, RUN1, RUN2, INTV <sub>CC</sub> , EXTV <sub>CC</sub> .....	-0.3V to 6V
MODE_PLLIN, f <sub>SET</sub> , TRACK1, TRACK2, DIFFOUT, PHASMD .....	-0.3V to INTV <sub>CC</sub>
$V_{OUT1}$ , $V_{OUT2}$ , $V_{OUTS1}$ , $V_{OUTS2}$ (Note 6) .....	-0.3V to 6V
DIFFP, DIFFN .....	-0.3V to INTV <sub>CC</sub>
INTV <sub>CC</sub> Peak Output Current .....	100mA
Internal Operating Temperature Range (Note 2) .....	-40°C to 125°C
Storage Temperature Range .....	-55°C to 125°C
Peak Package Body Temperature .....	245°C

## PIN CONFIGURATION

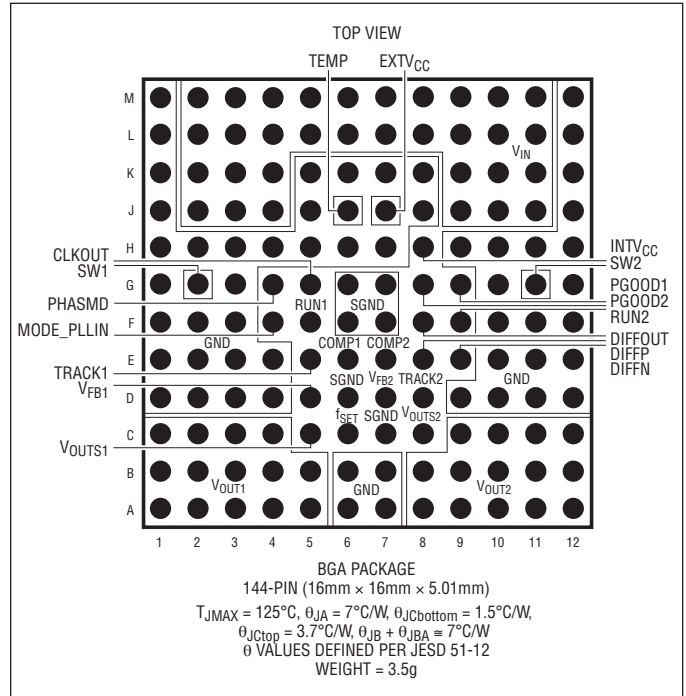

## ORDER INFORMATION

PART NUMBER	PAD OR BALL FINISH*	PART MARKING		PACKAGE TYPE	MSL RATING	TEMPERATURE RANGE (Note 2)
		DEVICE	FINISH CODE			
LTM4630EY-1A#PBF	SAC305 (RoHS)	LTM4630Y-1	e1	BGA	3	-40°C to 125°C
LTM4630IY-1A#PBF	SAC305 (RoHS)	LTM4630Y-1	e1	BGA	3	-40°C to 125°C
LTM4630EY-1B#PBF	SAC305 (RoHS)	LTM4630Y-1	e1	BGA	3	-40°C to 125°C
LTM4630IY-1B#PBF	SAC305 (RoHS)	LTM4630Y-1	e1	BGA	3	-40°C to 125°C
LTM4630IY-1A	SnPb (63/37)	LTM4630Y-1	e0	BGA	3	-40°C to 125°C
LTM4630IY-1B	SnPb (63/37)	LTM4630Y-1	e0	BGA	3	-40°C to 125°C

• Contact the factory for parts specified with wider operating temperature ranges. \*Pad or ball finish code is per IPC/JEDEC J-STD-609.

- [Recommended LGA and BGA PCB Assembly and Manufacturing Procedures](#)
- [LGA and BGA Package and Tray Drawings](#)

**ELECTRICAL CHARACTERISTICS** The ● denotes the specifications which apply over the specified internal operating temperature range. Specified as each individual output channel.  $T_A = 25^\circ\text{C}$  (Note 2),  $V_{IN} = 12\text{V}$  and  $V_{RUN1}$ ,  $V_{RUN2}$  at 5V unless otherwise noted. Per the typical application in Figure 25.

SYMBOL	PARAMETER	CONDITIONS	MIN	TYP	MAX	UNITS	
$V_{IN}$	Input DC Voltage		● 4.5		15	V	
$V_{OUT}$	Output Voltage		● 0.6		1.8	V	
$V_{OUT1(DC)}$ , $V_{OUT2(DC)}$	Output Voltage, Total Variation with Line and Load (Note 8)	$C_{IN} = 22\mu\text{F} \times 3$ , $C_{OUT} = 100\mu\text{F} \times 1$ Ceramic, 470 $\mu\text{F}$ POSCAP, $R_{FB} = 40.2\text{k}\Omega$ , $V_{IN} = 12\text{V}$ , $V_{OUT} = 1.5\text{V}$ , $I_{OUT} = 0\text{A}$ to 18A A-Grade (0.8%) B-Grade (1.5%)	● 1.488 ● 1.477	1.5 1.5	1.512 1.523	V V	
<b>Input Specifications</b>							
$V_{RUN1}$ , $V_{RUN2}$	RUN Pin On/Off Threshold	RUN Rising		1.1	1.25	1.40	V
$V_{RUN1HYS}$ , $V_{RUN2HYS}$	RUN Pin On Hysteresis			150			mV
$I_{INRUSH(VIN)}$	Input Inrush Current at Start-Up	$I_{OUT} = 0\text{A}$ , $C_{IN} = 22\mu\text{F} \times 3$ , $C_{SS} = 0.01\mu\text{F}$ , $C_{OUT} = 100\mu\text{F} \times 3$ , $V_{OUT1} = 1.5\text{V}$ , $V_{OUT2} = 1.5\text{V}$ , $V_{IN} = 12\text{V}$		1			A
$I_{Q(VIN)}$	Input Supply Bias Current	$V_{IN} = 12\text{V}$ , $V_{OUT} = 1.5\text{V}$ , Burst Mode® Operation $V_{IN} = 12\text{V}$ , $V_{OUT} = 1.5\text{V}$ , Pulse-Skipping Mode $V_{IN} = 12\text{V}$ , $V_{OUT} = 1.5\text{V}$ , Switching Continuous Shutdown, $RUN = 0$ , $V_{IN} = 12\text{V}$		3 15 65 50			mA mA mA $\mu\text{A}$
$I_{S(VIN)}$	Input Supply Current	$V_{IN} = 5\text{V}$ , $V_{OUT} = 1.5\text{V}$ , $I_{OUT} = 18\text{A}$ $V_{IN} = 12\text{V}$ , $V_{OUT} = 1.5\text{V}$ , $I_{OUT} = 18\text{A}$		6 2.6			A A
<b>Output Specifications</b>							
$I_{OUT1(DC)}$ , $I_{OUT2(DC)}$	Output Continuous Current Range	$V_{IN} = 12\text{V}$ , $V_{OUT} = 1.5\text{V}$ (Note 7)		0		18	A
$\Delta V_{OUT1(LINE)}/V_{OUT1}$ $\Delta V_{OUT2(LINE)}/V_{OUT2}$	Line Regulation Accuracy	$V_{OUT} = 1.5\text{V}$ , $V_{IN}$ from 4.5V to 15V, $I_{OUT} = 0\text{A}$ for Each Output	●	0.01	0.03		%/V
$\Delta V_{OUT1}/V_{OUT1}$ $\Delta V_{OUT2}/V_{OUT2}$	Load Regulation Accuracy	For Each Output, $V_{OUT} = 1.5\text{V}$ , 0A to 18A $V_{IN} = 12\text{V}$ (Note 7) A-Grade B-Grade	● ●	0.1 0.2	0.3 0.5		% %
$V_{OUT1(AC)}$ , $V_{OUT2(AC)}$	Output Ripple Voltage	For Each Output, $I_{OUT} = 0\text{A}$ , $C_{OUT} = 100\mu\text{F} \times 3$ / X7R/Ceramic, 470 $\mu\text{F}$ POSCAP, $V_{IN} = 12\text{V}$ , $V_{OUT} = 1.5\text{V}$ , Frequency = 450kHz		15			mV <sub>p-p</sub>
$f_S$ (Each Channel)	Output Ripple Voltage Frequency	$V_{IN} = 12\text{V}$ , $V_{OUT} = 1.5\text{V}$ , $f_{SET} = 1.25\text{V}$ (Note 4)		500			kHz
$f_{SYNC}$ (Each Channel)	SYNC Capture Range			400		750	kHz
$\Delta V_{OUTSTART}$ (Each Channel)	Turn-On Overshoot	$C_{OUT} = 100\mu\text{F}/\text{X5R}/\text{Ceramic}$ , 470 $\mu\text{F}$ POSCAP, $V_{OUT} = 1.5\text{V}$ , $I_{OUT} = 0\text{A}$ , $V_{IN} = 12\text{V}$		10			mV
$t_{START}$ (Each Channel)	Turn-On Time	$C_{OUT} = 100\mu\text{F}/\text{X5R}/\text{Ceramic}$ , 470 $\mu\text{F}$ POSCAP, No Load, TRACK/SS with 0.01 $\mu\text{F}$ to GND, $V_{IN} = 12\text{V}$		5			ms
$\Delta V_{OUT(LS)}$ (Each Channel)	Peak Deviation for Dynamic Load	Load: 0% to 25% to 0% of Full Load, $C_{OUT} = 5 \times 220\mu\text{F}$ Ceramic, $V_{IN} = 12\text{V}$ , $V_{OUT} = 1.5\text{V}$		83			mV
$t_{SETTLE}$ (Each Channel)	Settling Time for Dynamic Load Step	Load: 0% to 25% to 0% of Full Load, $V_{IN} = 12\text{V}$ , $V_{OUT} = 1.5\text{V}$ , $C_{OUT} = 5 \times 220\mu\text{F}$ Ceramic		40			$\mu\text{s}$
$I_{OUT(PK)}$ (Each Channel)	Output Current Limit	$V_{IN} = 12\text{V}$ , $V_{OUT} = 1.5\text{V}$		30			A

# LTM4630-1

**ELECTRICAL CHARACTERISTICS** The ● denotes the specifications which apply over the specified internal operating temperature range. Specified as each individual output channel.  $T_A = 25^\circ\text{C}$  (Note 2),  $V_{IN} = 12\text{V}$  and  $V_{RUN1}$ ,  $V_{RUN2}$  at 5V unless otherwise noted. Per the typical application in Figure 25.

SYMBOL	PARAMETER	CONDITIONS	MIN	TYP	MAX	UNITS	
<b>Control Section</b>							
$V_{FB1}$ , $V_{FB2}$	Voltage at $V_{FB}$ Pins	$I_{OUT} = 0\text{A}$ , $V_{OUT} = 1.5\text{V}$ A-Grade B-Grade	● ●	0.595 0.592	0.600 0.600	0.605 0.606	V V
$I_{FB}$		(Note 6)		-5	-20	nA	
$V_{OVL}$	Feedback Overvoltage Lockout		●	0.64	0.66	0.68	V
TRACK1 (I), TRACK2 (I)	Track Pin Soft-Start Pull-Up Current	TRACK1 (I), TRACK2 (I) Start at 0V		1	1.25	1.5	$\mu\text{A}$
UVLO	Undervoltage Lockout (Falling)			3.3		V	
UVLO Hysteresis				0.6		V	
$t_{ON(MIN)}$	Minimum On-Time	(Note 6)		90		ns	
$R_{FBH11}$ , $R_{FBH12}$	Resistor Between $V_{OUTS1}$ , $V_{OUTS2}$ and $V_{FB1}$ , $V_{FB2}$ Pins for Each Output			60.05	60.4	60.75	$\text{k}\Omega$
$V_{PGOOD1}$ , $V_{PGOOD2}$ Low	PGOOD Voltage Low	$I_{PGOOD} = 2\text{mA}$		0.1	0.3	V	
$I_{PGOOD}$	PGOOD Leakage Current	$V_{PGOOD} = 5\text{V}$			$\pm 5$	$\mu\text{A}$	
$V_{PGOOD}$	PGOOD Trip Level	$V_{FB}$ with Respect to Set Output Voltage $V_{FB}$ Ramping Negative $V_{FB}$ Ramping Positive		-10 10		% %	
<b>INTV<sub>CC</sub> Linear Regulator</b>							
$V_{INTVCC}$	Internal $V_{CC}$ Voltage	$6\text{V} < V_{IN} < 15\text{V}$		4.8	5	5.2	V
$V_{INTVCC}$ Load Regulation	INTV <sub>CC</sub> Load Regulation	$I_{CC} = 0\text{mA}$ to 50mA		0.5	2	%	
$V_{EXTVCC}$	EXTV <sub>CC</sub> Switchover Voltage	EXTV <sub>CC</sub> Ramping Positive		4.5	4.7	V	
$V_{EXTVCC(DROP)}$	EXTV <sub>CC</sub> Dropout	$I_{CC} = 20\text{mA}$ , $V_{EXTVCC} = 5\text{V}$		50	100	mV	
$V_{EXTVCC(HYST)}$	EXTV <sub>CC</sub> Hysteresis			220		mV	
<b>Oscillator and Phase-Locked Loop</b>							
Frequency Nominal	Nominal Frequency	$f_{SET} = 1.2\text{V}$		450	500	550	kHz
Frequency Low	Lowest Frequency	$f_{SET} = 0\text{V}$ (Note 5)		210	250	290	kHz
Frequency High	Highest Frequency	$f_{SET} > 2.4\text{V}$ , Up to INTV <sub>CC</sub>		700	780	860	kHz
$f_{SET}$	Frequency Set Current			9	10	11	$\mu\text{A}$
$R_{MODE\_PLLIN}$	MODE_PLLIN Input Resistance			250		$\text{k}\Omega$	
CLKOUT	Phase (Relative to $V_{OUT1}$ )	PHASMD = GND PHASMD = Float PHASMD = INTV <sub>CC</sub>		60 90 120		Deg Deg Deg	
CLK High	Clock High Output Voltage			2		V	
CLK Low	Clock Low Output Voltage				0.2	V	

**ELECTRICAL CHARACTERISTICS** The ● denotes the specifications which apply over the specified internal operating temperature range. Specified as each individual output channel.  $T_A = 25^\circ\text{C}$  (Note 2),  $V_{IN} = 12\text{V}$  and  $V_{RUN1}$ ,  $V_{RUN2}$  at 5V unless otherwise noted. Per the typical application in Figure 25.

SYMBOL	PARAMETER	CONDITIONS	MIN	TYP	MAX	UNITS
<b>Differential Amplifier</b>						
$A_V$ Differential Amplifier	Gain			1		V/V
$R_{IN}$	Input Resistance	Measured at DIFFP Input		80		$\text{k}\Omega$
$V_{OS}$	Input Offset Voltage	$V_{DIFFP} = V_{DIFFOUT} = 1.5\text{V}$ , $I_{DIFFOUT} = 100\mu\text{A}$			3	mV
PSRR Differential Amplifier	Power Supply Rejection Ratio	$5\text{V} < V_{IN} < 15\text{V}$		90		dB
$I_{CL}$	Maximum Output Current			3		mA
$V_{OUT(MAX)}$	Maximum Output Voltage	$I_{DIFFOUT} = 300\mu\text{A}$	$\text{INTV}_{CC} - 1.4$			V
GBW	Gain Bandwidth Product			3		MHz
$V_{TEMP}$	Diode Connected PNP	$I = 100\mu\text{A}$		0.6		V
TC	Temperature Coefficient		●	-2.2		mV/C

**Note 1:** Stresses beyond those listed under Absolute Maximum Ratings may cause permanent damage to the device. Exposure to any Absolute Maximum Rating condition for extended periods may affect device reliability and lifetime.

**Note 2:** The LTM4630-1 is tested under pulsed load conditions such that  $T_J \approx T_A$ . The LTM4630E-1 is guaranteed to meet specifications from  $0^\circ\text{C}$  to  $125^\circ\text{C}$  internal temperature. Specifications over the  $-40^\circ\text{C}$  to  $125^\circ\text{C}$  internal operating temperature range are assured by design, characterization and correlation with statistical process controls. The LTM4630I-1 is guaranteed over the full  $-40^\circ\text{C}$  to  $125^\circ\text{C}$  internal operating temperature range. Note that the maximum ambient temperature consistent with these specifications is determined by specific operating conditions in conjunction with board layout, the rated package thermal impedance and other environmental factors.

**Note 3:** Two outputs are tested separately and the same testing condition is applied to each output.

**Note 4:** The switching frequency is programmable from 400kHz to 750kHz.

**Note 5:** LTM4630-1 device is designed to operate from 400kHz to 750kHz

**Note 6:** These parameters are tested at wafer sort.

**Note 7:** See output current derating curves for different  $V_{IN}$ ,  $V_{OUT}$  and  $T_A$ .

**Note 8:** Total DC output voltage error includes all errors over temperature: Reference, line and load regulation as well as the tolerance of the integrated top feedback resistor.

## TYPICAL PERFORMANCE CHARACTERISTICS

**Efficiency vs Output Current,  
 $V_{IN} = 5V, f_s = 450kHz$**

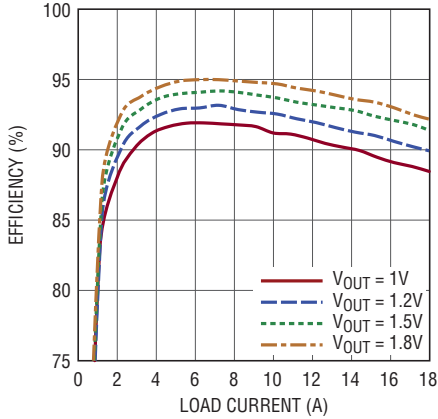

46301 G01

**Efficiency vs Output Current,  
 $V_{IN} = 12V, f_s = 450kHz$**

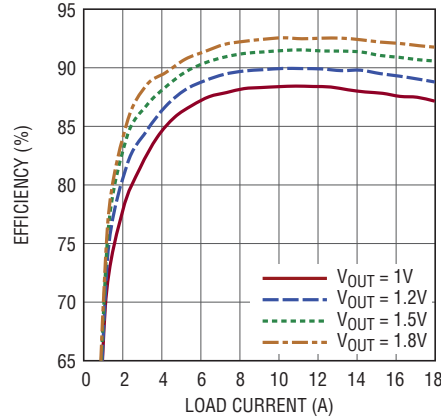

46301 G02

**Dual Phase Single Output Efficiency  
vs Output Current,  $V_{IN} = 12V,$   
 $f_s = 450kHz$**

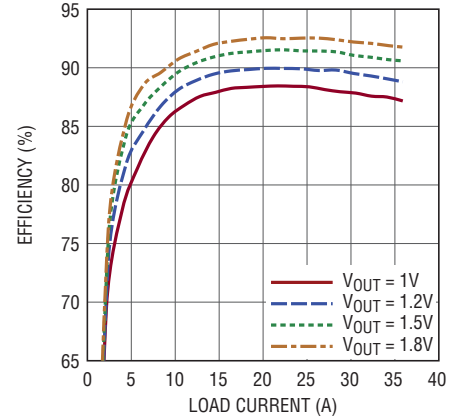

46301 G03

**Burst Mode and Pulse-Skip Mode  
Efficiency  $V_{IN} = 12V, V_{OUT} = 1.2V,$   
 $f_s = 450kHz$**

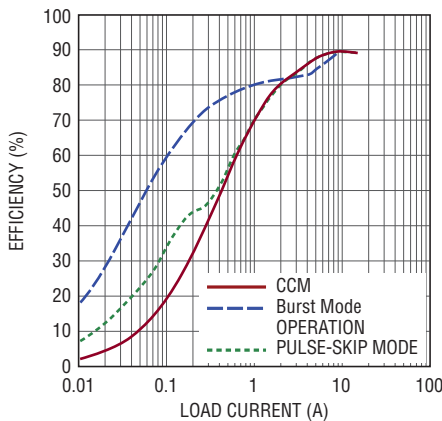

46301 G04

**Dual Phase Single Output  
25% (9A) Transient Response  
at 0.9V Output**

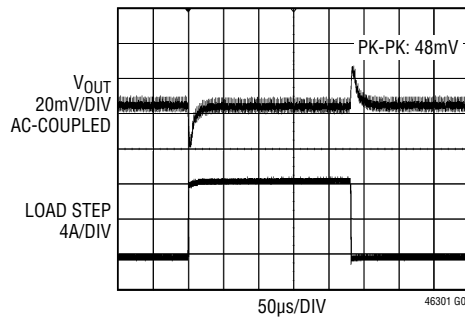

12VIN, 0.9VOUT, 450kHz  
9A LOAD STEP, 10A/μs LOAD SLEW RATE  
COUT = 12 × 100μF 6.3V CERAMIC,  
CTH = 2200pF, RTH = 4.24k, CFF = 33pF

**Dual Phase Single Output  
25% (9A) Transient Response  
at 1V Output**

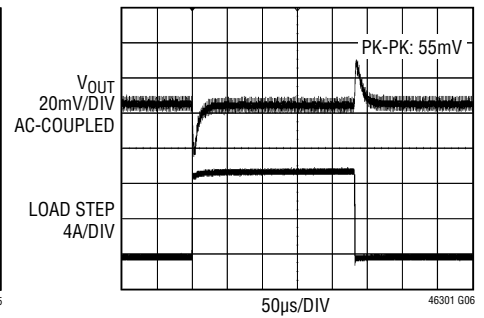

12VIN, 1VOUT, 450kHz  
9A LOAD STEP, 10A/μs LOAD SLEW RATE  
COUT = 12 × 100μF 6.3V CERAMIC,  
CTH = 2200pF, RTH = 4.24k, CFF = 33pF

**Dual Phase Single Output  
25% (9A) Transient Response  
at 1.2V Output**

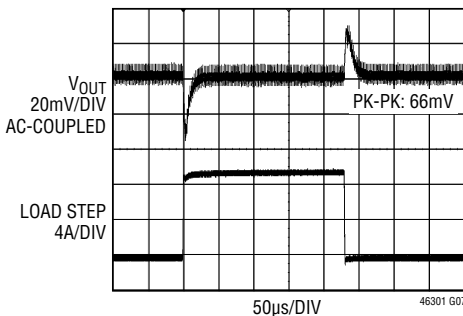

12VIN, 1.2VOUT, 450kHz  
9A LOAD STEP, 10A/μs LOAD SLEW RATE  
COUT = 10 × 100μF 6.3V CERAMIC,  
CTH = 2200pF, RTH = 3.75k, CFF = 33pF

**Dual Phase Single Output  
25% (9A) Transient Response  
at 1.5V Output**

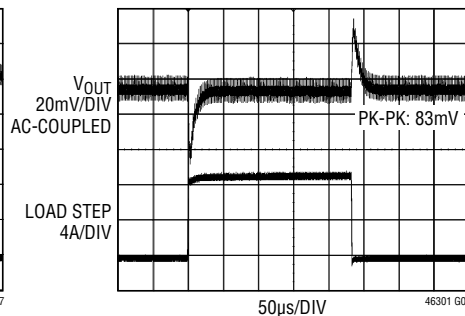

12VIN, 1.5VOUT, 450kHz  
9A LOAD STEP, 10A/μs LOAD SLEW RATE  
COUT = 8 × 100μF 6.3V CERAMIC,  
CTH = 2200pF, RTH = 4.02k, CFF = 33pF

**Dual Phase Single Output  
25% (9A) Transient Response  
at 1.8V Output**

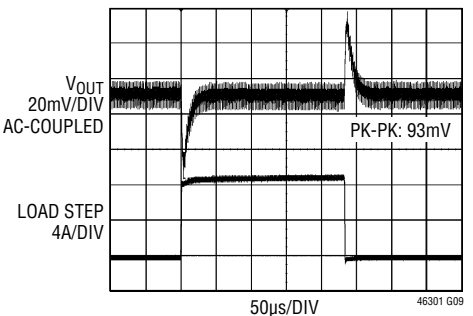

12VIN, 1.8VOUT, 450kHz  
9A LOAD STEP, 10A/μs LOAD SLEW RATE  
COUT = 7 × 100μF 6.3V CERAMIC,  
CTH = 2200pF, RTH = 4.02k, CFF = 33pF

## TYPICAL PERFORMANCE CHARACTERISTICS

### Single Phase Start-Up with No load

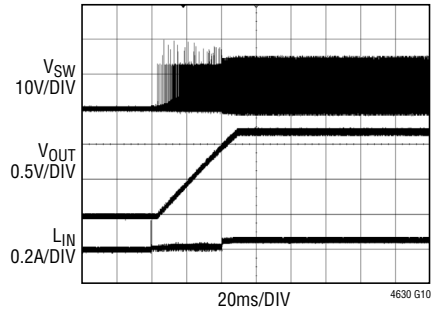

12V<sub>IN</sub>, 1.2V<sub>OUT</sub>, 450kHz  
 $C_{OUT} = 1 \times 470\mu\text{F}$  4V POSCAP +  $1 \times 100\mu\text{F}$  6.3V CERAMIC,  $C_{SS} = 0.1\mu\text{F}$

### Single Phase Start-Up with 18A

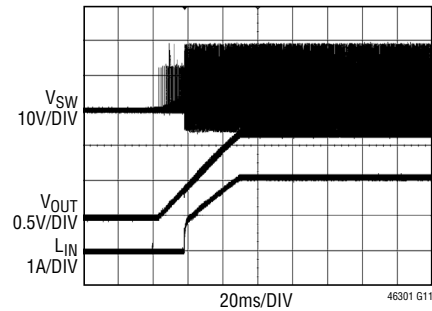

12V<sub>IN</sub>, 1.2V<sub>OUT</sub>, 450kHz  
 $C_{OUT} = 1 \times 470\mu\text{F}$  4V POSCAP +  $1 \times 100\mu\text{F}$  6.3V CERAMIC,  $C_{SS} = 0.1\mu\text{F}$

### Single Phase Short-Circuit Protection with No load

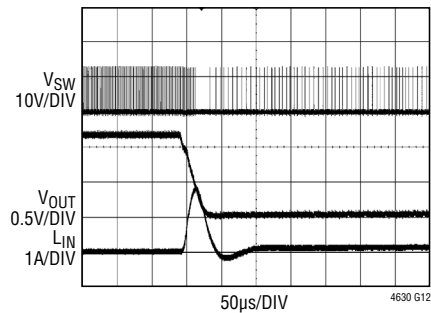

12V<sub>IN</sub>, 1.2V<sub>OUT</sub>, 450kHz  
 $C_{OUT} = 1 \times 470\mu\text{F}$  4V POSCAP +  $1 \times 100\mu\text{F}$  6.3V CERAMIC

### Single Phase Short-Circuit Protection with 18A

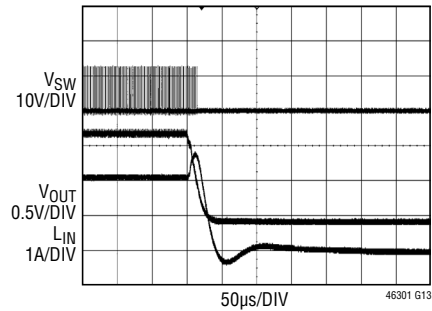

12V<sub>IN</sub>, 1.2V<sub>OUT</sub>, 450kHz  
 $C_{OUT} = 1 \times 470\mu\text{F}$  4V POSCAP +  $1 \times 100\mu\text{F}$  6.3V CERAMIC

## PIN FUNCTIONS (Recommended to use Test Points to monitor signal pin connections.)

**V<sub>OUT1</sub> (A1-A5, B1-B5, C1-C4):** Power Output Pins. Apply output load between these pins and GND pins. Recommend placing output decoupling capacitance directly between these pins and GND pins. Review Table 4.

**GND (A6-A7, B6-B7, D1-D4, D9-D12, E1-E4, E10-E12, F1-F3, F10-F12, G1, G3, G10, G12, H1-H7, H9-H12, J1, J5, J8, J12, K1, K5-K8, K12, L1, L12, M1, M12):** Power Ground Pins for Both Input and Output Returns.

**V<sub>OUT2</sub> (A8-A12, B8-B12, C9-C12):** Power Output Pins. Apply output load between these pins and GND pins. Recommend placing output decoupling capacitance directly between these pins and GND pins. Review Table 4.

**V<sub>OUTS1</sub>, V<sub>OUTS2</sub> (C5, C8):** This pin is connected to the top of the internal top feedback resistor for each output. The pin can be directly connected to its specific output, or connected to DIFFOUT when the remote sense amplifier is used. In paralleling modules, one of the V<sub>OUTS</sub> pins is connected to the DIFFOUT pin in remote sensing or directly to V<sub>OUT</sub> with no remote sensing. It is very important to connect these pins to either the DIFFOUT or V<sub>OUT</sub> since this is the feedback path, and cannot be left open. See the Applications Information section.

**f<sub>SET</sub> (C6):** Frequency Set Pin. A 10 $\mu$ A current is sourced from this pin. A resistor from this pin to ground sets a voltage that in turn programs the operating frequency. Alternatively, this pin can be driven with a DC voltage that can set the operating frequency. See the Applications Information section.

**SGND (C7, D6, G6-G7, F6-F7):** Signal Ground Pin. Return ground path for all analog and low power circuitry. Tie a single connection to the output capacitor GND in the application. See Figure 14 in the Layout Checklist/Example section.

**V<sub>FB1</sub>, V<sub>FB2</sub> (D5, D7):** The Negative Input of the Error Amplifier for Each Channel. Internally, this pin is connected to V<sub>OUTS1</sub> or V<sub>OUTS2</sub> with a 60.4k precision resistor. Different output voltages can be programmed with an additional resistor between V<sub>FB</sub> and GND pins. In

PolyPhase<sup>®</sup> operation, tying the V<sub>FB</sub> pins together allows for parallel operation. See the Applications Information section for details. Do not drive this pin.

**TRACK1, TRACK2 (E5, D8):** Output Voltage Tracking Pin and Soft-Start Inputs. Each channel has a 1.3 $\mu$ A pull-up current source. When one channel is configured to be the main channel of the two channels, then a capacitor from this pin to ground will set a soft-start ramp rate. The remaining channel can be set up as the subordinate channel, and have the main device's output applied through a voltage divider to the subordinate device output's track pin. This voltage divider is equal to the subordinate device output's feedback divider for coincidental tracking. See the Applications Information section.

**COMP1, COMP2 (E6, E7):** Current control threshold and error amplifier compensation point for each channel. The current comparator threshold increases with this control voltage. COMP pin internal has 10pF filter capacitor to SGND. An external RC filter circuit is required for control loop compensation. See Applications Information section. Tie the COMP pins together for parallel operation. Do not drive this pin.

**DIFFP (E8):** Positive input of the remote sense amplifier. This pin is connected to the remote sense point of the output voltage. See the Applications Information section.

**DIFFN (E9):** Negative input of the remote sense amplifier. This pin is connected to the remote sense point of the output GND. See the Applications Information section.

**MODE\_PLLIN (F4):** Forced Continuous Mode, Burst Mode Operation, or Pulse-Skipping Mode Selection Pin and External Synchronization Input to Phase Detector Pin. Connect this pin to SGND to force both channels into forced continuous mode of operation. Connect to INTV<sub>CC</sub> to enable pulse-skipping mode of operation. Leaving the pin floating will enable Burst Mode operation. A clock on the pin will force both channels into continuous mode of operation and synchronized to the external clock applied to this pin.



## PIN FUNCTIONS (Recommended to use Test Points to monitor signal pin connections.)

**RUN1, RUN2 (F5, F9):** Run Control Pin. A voltage above 1.25V will turn on each channel in the module. A voltage below 1.25V on the RUN pin will turn off the related channel. Each RUN pin has a 1 $\mu$ A pull-up current, once the RUN pin reaches 1.2V an additional 4.5 $\mu$ A pull-up current is added to this pin.

**DIFFOUT (F8):** Internal Remote Sense Amplifier Output. Connect this pin to  $V_{OUTS1}$  or  $V_{OUTS2}$  depending on which output is using remote sense. In parallel operation connect one of the  $V_{OUTS}$  pin to DIFFOUT for remote sensing.

**SW1, SW2 (G2, G11):** Switching node of each channel that is used for testing purposes. Also, an R-C snubber network can be applied to reduce or eliminate switch node ringing, or otherwise leave this pin floating. See the Applications Information section.

**PHASMD (G4):** Connect this pin to SGND, INTV<sub>CC</sub>, or floating this pin to select the phase of CLKOUT to 60 degrees, 120 degrees, and 90 degrees, respectively.

**CLKOUT (G5):** Clock output with phase control using the PHASMD pin to enable multiphase operation between devices. See the Applications Information section.

**PGOOD1, PGOOD2 (G9, G8):** Output Voltage Power Good Indicator. Open-drain logic output that is pulled to ground when the output voltage is not within  $\pm 10\%$  of the regulation point.

**INTV<sub>CC</sub> (H8):** Internal 5V Regulator Output. The control circuits and internal gate drivers are powered from this voltage. Decouple this pin to PGND with a 4.7 $\mu$ F low ESR tantalum or a ceramic capacitor. INTV<sub>CC</sub> is activated when either RUN1 or RUN2 is activated.

**TEMP (J6):** Onboard General Purpose Temperature Diode for Monitoring the  $V_{BE}$  Junction Voltage Change with Temperature. See the Applications Information section.

**EXTV<sub>CC</sub> (J7):** External power input that is enabled through a switch to INTV<sub>CC</sub> whenever EXTV<sub>CC</sub> is greater than 4.7V. Do not exceed 6V on this input, and connect this pin to  $V_{IN}$  when operating  $V_{IN}$  on 5V. An efficiency increase will occur that is a function of the  $(V_{IN} - INTV_{CC})$  multiplied by power MOSFET driver current. Typical current requirement is 30mA.  $V_{IN}$  must be applied before EXTV<sub>CC</sub>, and EXTV<sub>CC</sub> must be removed before  $V_{IN}$ .

**$V_{IN}$  (M2-M11, L2-L11, J2-J4, J9-J11, K2-K4, K9-K11):** Power Input Pins. Apply input voltage between these pins and GND pins. Recommend placing input decoupling capacitance directly between  $V_{IN}$  pins and GND pins.

# SIMPLIFIED BLOCK DIAGRAM

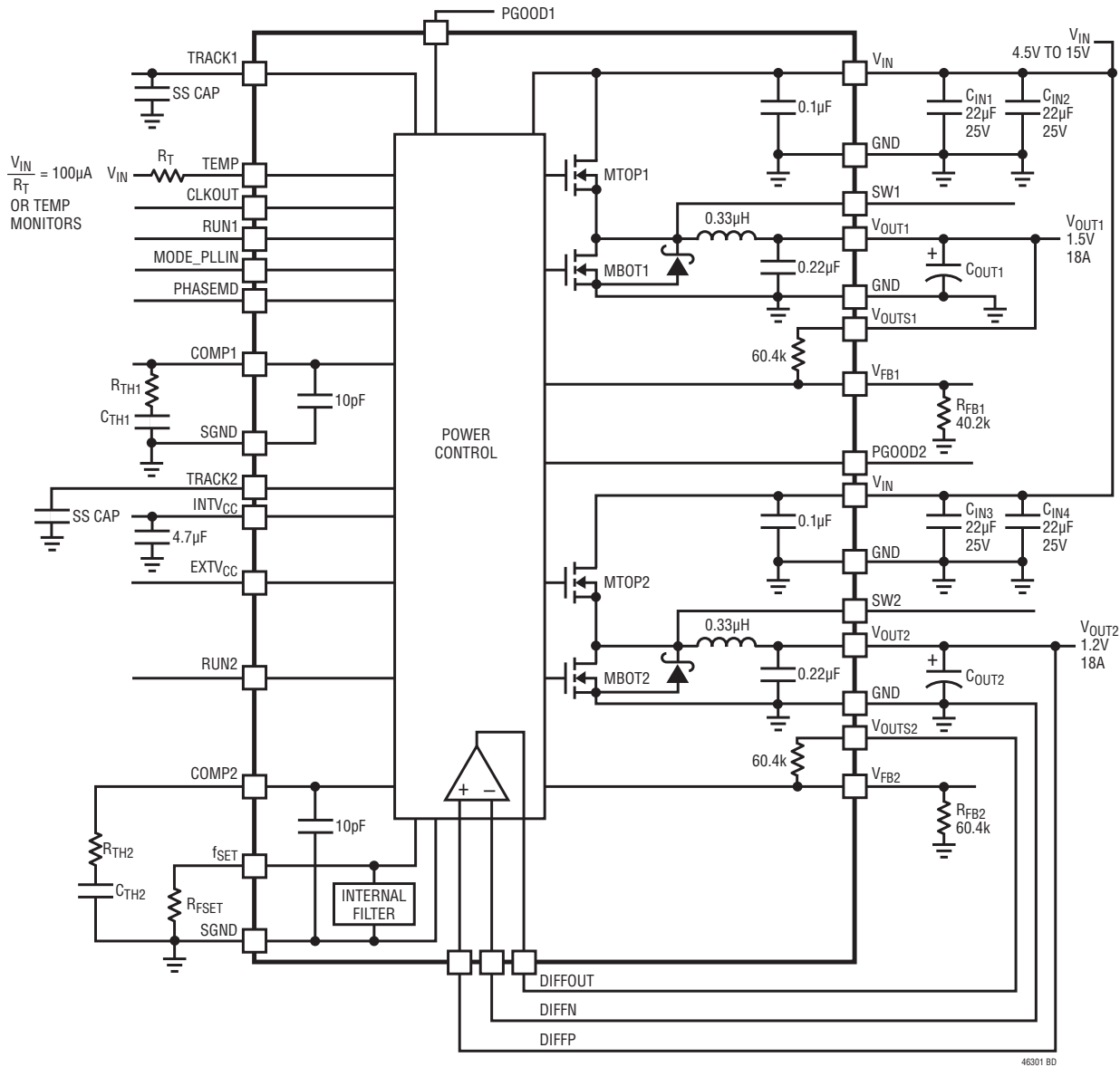

Figure 1. Simplified LTM4630-1 Block Diagram

## DECOUPLING REQUIREMENTS $T_A = 25^\circ\text{C}$ . Use Figure 1 configuration.

SYMBOL	PARAMETER	CONDITIONS	MIN	TYP	MAX	UNITS
$C_{IN1}, C_{IN2}$ $C_{IN3}, C_{IN4}$	External Input Capacitor Requirement ( $V_{IN1} = 4.5\text{V to }15\text{V}, V_{OUT1} = 1.5\text{V}$ ) ( $V_{IN2} = 4.5\text{V to }15\text{V}, V_{OUT2} = 1.2\text{V}$ )	$I_{OUT1} = 18\text{A}$ $I_{OUT2} = 18\text{A}$		44		$\mu\text{F}$
$C_{OUT1}$ $C_{OUT2}$	External Output Capacitor Requirement ( $V_{IN1} = 4.5\text{V to }15\text{V}, V_{OUT1} = 1.5\text{V}$ ) ( $V_{IN2} = 4.5\text{V to }15\text{V}, V_{OUT2} = 1.2\text{V}$ )	$I_{OUT1} = 18\text{A}$ $I_{OUT2} = 18\text{A}$		400		$\mu\text{F}$

## OPERATION

### Power Module Description

The LTM4630-1 is a dual-output standalone nonisolated switching mode DC/DC power supply with  $\pm 0.8\%$  total DC output error over line, load, and temperature variation. It can provide two 18A outputs or single 36A output with few external input and output capacitors and setup components. This module provides precisely regulated output voltages programmable via external resistors from 0.6VDC to 1.8VDC over 4.5V to 15V input voltages. The typical application schematic is shown in Figure 25.

The LTM4630-1 has dual integrated constant-frequency current mode regulators and built-in power MOSFET devices with fast switching speed. The typical switching frequency is 500kHz. For switching-noise sensitive applications, it can be externally synchronized from 400kHz to 750kHz. A resistor can be used to program a free run frequency on the  $f_{SET}$  pin. See the Applications Information section.

With current mode control, multi LTM4630-1s can be easily paralleled to provide up to 144A current with guaranteed perfect current sharing. Also, with current mode control, the LTM4630-1 module is able to achieve sufficient stability margins and a very fast  $\pm 3\%$  output error including transients with a minimum number of output capacitors, even with all ceramic output capacitors.

This makes LTM4630-1 the best candidate when powering FPGAs, ASICs and processors in terms of DC accuracy, AC transient response, high output current, and accuracy current sharing. See Applications Information section.

Current mode control provides cycle-by-cycle fast current limit and foldback current limit in an overcurrent condition. Internal overvoltage and undervoltage comparators pull the open-drain PGOOD outputs low if the output feedback voltage exits a  $\pm 10\%$  window around the regulation point. As the output voltage exceeds 10% above regulation, the bottom MOSFET will turn on to clamp the output voltage. The top MOSFET will be turned off. This overvoltage protect is feedback voltage referred.

Pulling the RUN pins below 1.1V forces the regulators into a shutdown state, by turning off both MOSFETs. The TRACK pins are used for programming the output voltage ramp and voltage tracking during start-up or used for soft-starting the regulator. See the Applications Information section.

The LTM4630-1 has a built-in 10pF high frequency filter capacitor from COMP to SGND for each output. An external RC filtering circuit is required to achieve fast Type II control loop compensation. Table 4 provides a guide line for input, output capacitances, and RC COMP values for several operating conditions. The Analog Devices  $\mu$ Module power design tool (LTpowerCAD<sup>®</sup>) provides transient and stability analysis. The  $V_{FB}$  pin is used to program the output voltage with a single external resistor to ground. A differential remote sense amplifier is available for sensing the output voltage accurately on one of the outputs at the load point, or in parallel operation sensing the output voltage at the load point.

High efficiency at light loads can be accomplished with selectable Burst Mode operation or pulse-skipping operation using the MODE\_PLLIN pin. These light load features will accommodate battery operation. Efficiency graphs are provided for light load operation in the Typical Performance Characteristics section. See the Applications Information section for details.

A general-purpose temperature diode is included inside the module to monitor the temperature of the module. See the Applications Information section for details.

The switch pins are available for functional operation monitoring and a resistor-capacitor snubber circuit can be carefully placed on the switch pin to ground to dampen any high frequency ringing on the transition edges. See the Applications Information section for details.

## APPLICATIONS INFORMATION

The typical LTM4630-1 application circuit is shown in Figure 25. External component selection is primarily determined by the maximum load current and output voltage. See Table 4 for specific external capacitor requirements to achieve  $\pm 3\%$  transient response for a 25% or a 50% load step application.

### OUTPUT TOTAL DC ACCURACY AND AC TRANSIENT PERFORMANCE

In modern ASIC and FPGA power supply designs, a tight total voltage regulation window,  $\pm 3\%$  for example, is required of the supply powering the core and periphery. To meet this requirement, the supply's DC voltage variance plus any AC voltage variation which may occur during any load step transient must fall within this allowed window. The DC voltage variance is determined by the accuracies of the supply's reference voltage, resistor divider, load regulation, and line regulation over the operating temperature range. The AC voltage variance is determined by the supply's output voltage overshoot and undershoots in response to a load transient condition for a given output capacitor network.

Figure 2 shows a typical load step transient response waveform together with DC voltage accuracy variance. For a given allowable voltage regulation window, a tighter DC voltage accuracy allows more margin for the AC variation due to a load transient response. This increased margin for AC variation allows for a reduction in the total output capacitance required to meet the regulation window requirement. This allows for a reduced total solution cost and footprint area.

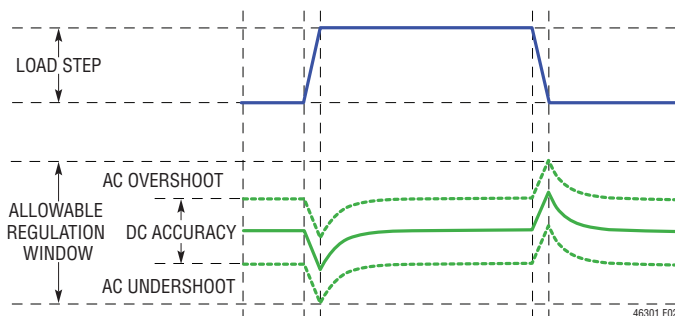

**Figure 2. Typical Load Step Transient Response with DC Voltage Accuracy Variance**

For example, in an FPGA core voltage application, for a 12V input, 0.9V output at 72A design, a total overall  $\pm 3\%$  total voltage regulation window is required in responding to a 25% load step transient. Figure 3 illustrates the benefit of overall output capacitor reduction versus improved total DC accuracy by using 100 $\mu$ F ceramic output capacitors.

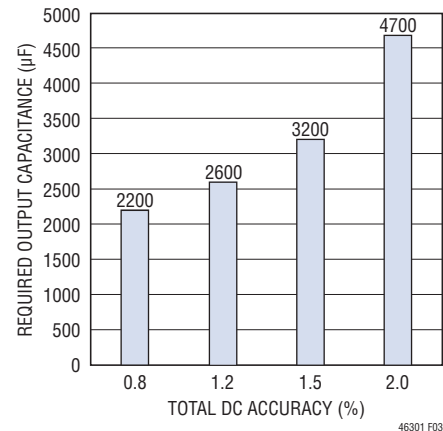

**Figure 3. Overall Output Capacitor vs Total DC Accuracy**

### $V_{IN}$ to $V_{OUT}$ Step-Down Ratios

There are restrictions in the maximum  $V_{IN}$  and  $V_{OUT}$  step-down ratio that can be achieved for a given input voltage. Each output of the LTM4630-1 is capable of 98% duty cycle, but the  $V_{IN}$  to  $V_{OUT}$  minimum dropout is still shown as a function of its load current and will limit output current capability related to high duty cycle on the top-side switch. Minimum on-time  $t_{ON(MIN)}$  is another consideration in operating at a specified duty cycle while operating at a certain frequency due to the fact that  $t_{ON(MIN)} < D/f_{SW}$ , where  $D$  is duty cycle and  $f_{SW}$  is the switching frequency.  $t_{ON(MIN)}$  is specified in the electrical parameters as 90ns.

### Output Voltage Programming

The PWM controller has an internal 0.6V reference voltage. As shown in the Simplified Block Diagram, a 60.4k internal feedback resistor connects between the  $V_{OUTS1}$  to  $V_{FB1}$  and  $V_{OUTS2}$  to  $V_{FB2}$ . It is very important that these pins be connected to their respective outputs for proper feedback regulation. Overvoltage can occur if these  $V_{OUTS1}$  and  $V_{OUTS2}$  pins are left floating when used as individual regulators, or at least one of them is used in paralleled regulators. The output voltage will default to

## APPLICATIONS INFORMATION

0.6V with no feedback resistor on either  $V_{FB1}$  or  $V_{FB2}$ . Adding a resistor  $R_{FB}$  from  $V_{FB}$  pin to GND programs the output voltage:

$$V_{OUT} = 0.6V \cdot \frac{60.4k + R_{FB}}{R_{FB}}$$

**Table 1.  $V_{FB}$  Resistor Table vs Various Output Voltages**

$V_{OUT}$	0.6V	1.0V	1.2V	1.5V	1.8V
$R_{FB}$	Open	90.9k	60.4k	40.2k	30.2k

For parallel operation of multiple channels, the same feedback setting resistor can be used for the parallel design. This is done by connecting the  $V_{OUTS1}$  to the output as shown in Figure 4, thus tying one of the internal 60.4k resistors to the output. All of the  $V_{FB}$  pins tie together with one programming resistor as shown in Figure 4.

In parallel operation, the  $V_{FB}$  pins have an  $I_{FB}$  current of 20nA maximum each channel. To reduce output voltage error due to this current, an additional  $V_{OUTS}$  pin can be tied to  $V_{OUT}$ , and an additional  $R_{FB}$  resistor can be used to lower the total Thevenin equivalent resistance seen by this current. For example, in Figure 4, the total Thevenin equivalent resistance of the  $V_{FB}$  pin is  $(60.4k//R_{FB})$ , which is 30.2k where  $R_{FB}$  is equal to 60.4k for a 1.2V output. Four phases connected in parallel equates to a worst-case feedback current of  $4 \cdot I_{FB} = 80nA$  maximum. The voltage error is  $80nA \cdot 30.2k = 2.4mV$ . If  $V_{OUTS2}$  is connected, as shown in Figure 4, to  $V_{OUT}$ , and another 60.4k resistor is connected from  $V_{FB2}$  to ground, then the voltage error is reduced to 1.2mV. If the voltage error is acceptable then no additional connections are necessary. The onboard 60.4k resistor is 0.5% accurate and the  $V_{FB}$  resistor can be chosen by the user to be as accurate as needed. All COMP pins are tied together for current sharing between the phases. The TRACK/SS pins can be tied together and a single soft-start capacitor can be used to soft-start the regulator. The soft-start equation will need to have the soft-start current parameter increased by the number of paralleled channels. See Output Voltage Tracking section.

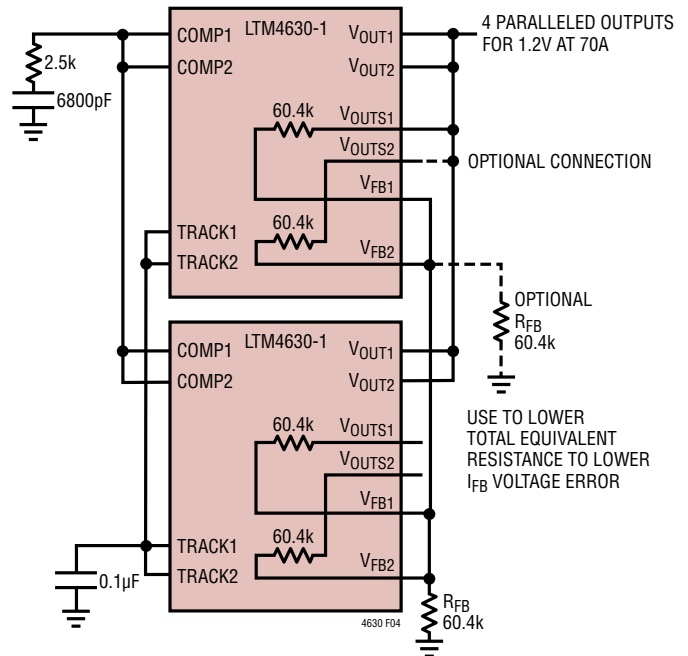

**Figure 4. 4-Phase Parallel Configurations**

### Input Capacitors

The LTM4630-1 module should be connected to a low AC-impedance DC source. For the regulator input four 22 $\mu$ F input ceramic capacitors are used for RMS ripple current. A 47 $\mu$ F to 100 $\mu$ F surface mount aluminum electrolytic bulk capacitor can be used for more input bulk capacitance. This bulk input capacitor is only needed if the input source impedance is compromised by long inductive leads, traces or not enough source capacitance. If low impedance power planes are used, then this bulk capacitor is not needed.

For a buck converter, the switching duty-cycle can be estimated as:

$$D = \frac{V_{OUT}}{V_{IN}}$$

## APPLICATIONS INFORMATION

Without considering the inductor current ripple, for each output, the RMS current of the input capacitor can be estimated as:

$$I_{\text{CIN(RMS)}} = \frac{I_{\text{OUT(MAX)}}}{\eta\%} \cdot \sqrt{D \cdot (1-D)}$$

In the above equation,  $\eta\%$  is the estimated efficiency of the power module. The bulk capacitor can be a switcher-rated electrolytic aluminum capacitor, Polymer capacitor.

### Output Capacitors

The LTM4630-1 is designed for low output voltage ripple noise and good transient response. The bulk output capacitors defined as  $C_{\text{OUT}}$  are chosen with low enough effective series resistance (ESR) to meet the output voltage ripple and transient requirements.  $C_{\text{OUT}}$  can be a low ESR tantalum capacitor, the low ESR polymer capacitor or ceramic capacitor. The typical output capacitance range for each output is from 200 $\mu\text{F}$  to 470 $\mu\text{F}$  per output channel. Additional output filtering may be required by the system designer, if further reduction of output ripples or dynamic transient spikes is required. Table 4 shows a matrix of different output voltages and output capacitors to minimize the voltage droop and overshoot to achieve  $\pm 3\%$  transient accuracy during a 25% load step. In multi LTM4630-1 paralleling applications, Table 4 RC compensation value is still valid in terms of having one set of RC filters on each of the paralleling modules while connecting all the COMP, FB and  $V_{\text{OUT}}$  pins together. See Figure 28 and Multiphase Operation section. Table 4 optimizes total equivalent ESR and total bulk capacitance to optimize the transient performance. Stability criteria are considered in the Table 4 matrix, and the Analog Devices  $\mu\text{Module}$  power design tool will be provided for stability analysis. Multiphase operation will reduce effective output ripple as a function of the number of phases. [Application Note 77](#) discusses this noise reduction versus output ripple current cancellation, but the output capacitance should be considered carefully as a function of stability and transient response. The Analog Devices  $\mu\text{Module}$  power design tool can calculate the output ripple reduction as the number of implemented phases increases by N times.

A small value 10 $\Omega$  to 50 $\Omega$  resistor can be placed in series from  $V_{\text{OUT}}$  to the  $V_{\text{OUTS}}$  pin to allow for a bode plot analyzer to inject a signal into the control loop and validate the regulator stability. The same resistor could be placed in series from  $V_{\text{OUT}}$  to DIFFP and a bode plot analyzer could inject a signal into the control loop and validate the regulator stability.

### Burst Mode Operation

The LTM4630-1 is capable of Burst Mode operation on each regulator in which the power MOSFETs operate intermittently based on load demand, thus saving quiescent current. For applications where maximizing the efficiency at very light loads is a high priority, Burst Mode operation should be applied. Burst Mode operation is enabled with the MODE\_PLLIN pin floating. During this operation, the peak current of the inductor is set to approximately one third of the maximum peak current value in normal operation even though the voltage at the COMP pin indicates a lower value. The voltage at the COMP pin drops when the inductor's average current is greater than the load requirement. As the COMP voltage drops below 0.5V, the BURST comparator trips, causing the internal sleep line to go high and turn off both power MOSFETs.

In sleep mode, the internal circuitry is partially turned off, reducing the quiescent current to about 450 $\mu\text{A}$  for each output. The load current is now being supplied from the output capacitors. When the output voltage drops, causing COMP to rise above 0.5V, the internal sleep line goes low, and the LTM4630-1 resumes normal operation. The next oscillator cycle will turn on the top power MOSFET and the switching cycle repeats. Either regulator can be configured for Burst Mode operation.

### Pulse-Skipping Mode Operation

In applications where low output ripple and high efficiency at intermediate currents are desired, pulse-skipping mode should be used. Pulse-skipping operation allows the LTM4630-1 to skip cycles at low output loads, thus increasing efficiency by reducing switching loss. Tying the MODE\_PLLIN pin to INTV $_{\text{CC}}$  enables pulse-skipping operation. At light loads the internal current comparator

## APPLICATIONS INFORMATION

may remain tripped for several cycles and force the top MOSFET to stay off for several cycles, thus skipping cycles. The inductor current does not reverse in this mode. This mode will maintain higher effective frequencies thus lower output ripple and lower noise than Burst Mode operation. Either regulator can be configured for pulse-skipping mode.

### Forced Continuous Operation

In applications where fixed frequency operation is more critical than low current efficiency, and where the lowest output ripple is desired, forced continuous operation should be used. Forced continuous operation can be enabled by tying the MODE\_PLLIN pin to GND. In this mode, inductor current is allowed to reverse during low output loads, the COMP voltage is in control of the current comparator threshold throughout, and the top MOSFET always turns on with each oscillator pulse. During start-up, forced continuous mode is disabled and inductor current is prevented from reversing until the LTM4630-1's output voltage is in regulation. Either regulator can be configured for forced continuous mode.

### Multiphase Operation

For output loads that demand more than 18A of current, two outputs in LTM4630-1 or even multiple LTM4630-1s can be paralleled to run out of phase to provide more output current without increasing input and output voltage ripples. The MODE\_PLLIN pin allows the LTM4630-1 to synchronize to an external clock (between 400kHz and 750kHz) and the internal phase-locked-loop allows the LTM4630-1 to lock onto incoming clock phase as well. The CLKOUT signal can be connected to the MODE\_PLLIN pin of the following stage to line up both the frequency and the phase of the entire system. Tying the PHASMD pin to INTV<sub>CC</sub>, SGND, or (floating) generates a phase difference (between MODE\_PLLIN and CLKOUT) of 120 degrees, 60 degrees, or 90 degrees respectively. A total of 12 phases can be cascaded to run simultaneously with respect to each other by programming the PHASMD pin of each LTM4630-1 channel to different levels. Figure 5 shows a 2-phase design, 4-phase design and a 6-phase design example for clock phasing with the PHASMD table.

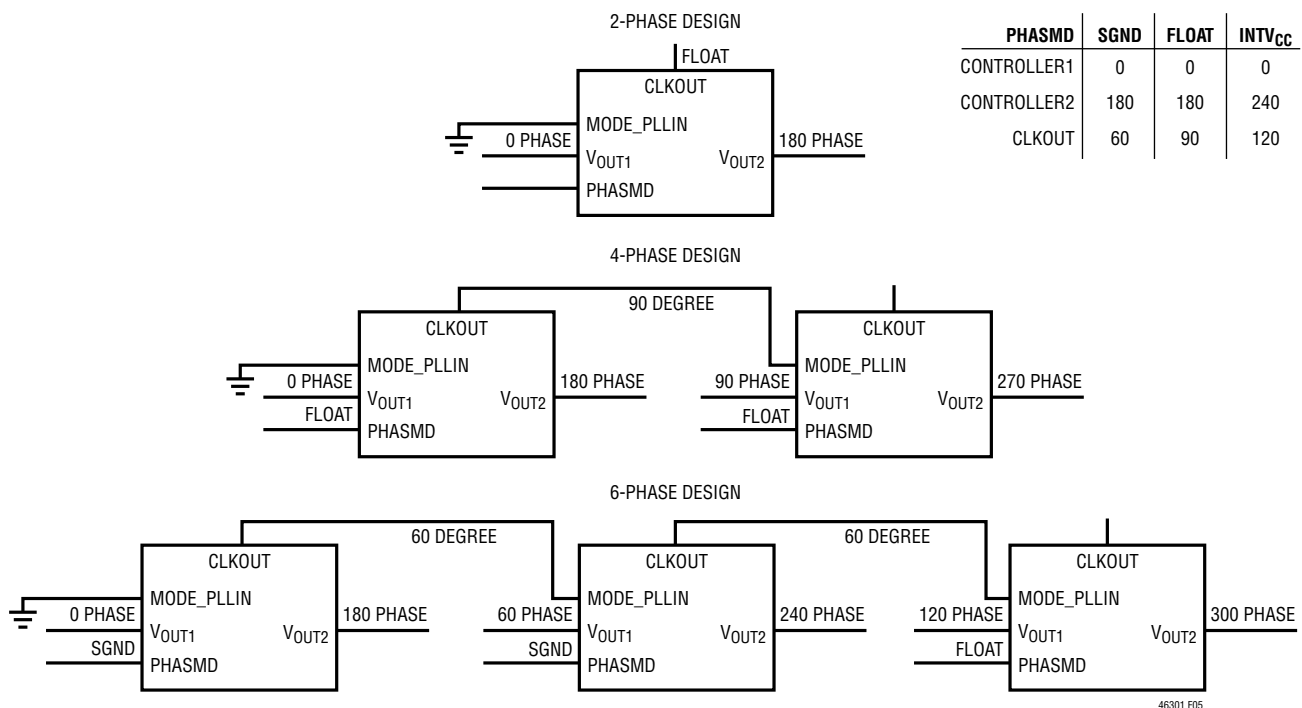

Figure 5. Examples of 2-Phase, 4-Phase, and 6-Phase Operation with PHASMD Table

## APPLICATIONS INFORMATION

A multiphase power supply significantly reduces the amount of ripple current in both the input and output capacitors. The RMS input ripple current is reduced by, and the effective ripple frequency is multiplied by, the number of phases used (assuming that the input voltage is greater than the number of phases used times the output voltage). The output ripple amplitude is also reduced by the number of phases used when all of the outputs are tied together to achieve a single high output current design.

In multi LTM4630-1s parallel applications,  $C_{TH}$  and  $R_{TH}$  values in Table 4 are still valid to achieve a  $\pm 3\%$  transient response in a 25% load step. Connect one set of RC ( $R_{TH}$  and  $C_{TH}$ ) network to the COMP pin of each paralleling module like a dual phase single output setup. Then connect the COMP pins, FB pins, TRACK/SS pin and  $V_{OUT}$  pins from different modules together. See Figure 28 for an

example of parallel operation. The LTpowerCAD® power design tool can also be used to optimize loop compensation and transient performance if only one set of RC ( $R_{TH}$  and  $C_{TH}$ ) network is to be added to the common COMP pins.

The LTM4630-1 device is an inherently current mode controlled device, so parallel modules will have very good current sharing. This will balance the thermals on the design.

### Input RMS Ripple Current Cancellation

Analog Devices [Application Note 77](#) provides a detailed explanation of multiphase operation. The input RMS ripple current cancellation mathematical derivations are presented, and a graph is displayed representing the RMS ripple current reduction as a function of the number of interleaved phases. Figure 6 shows this graph.

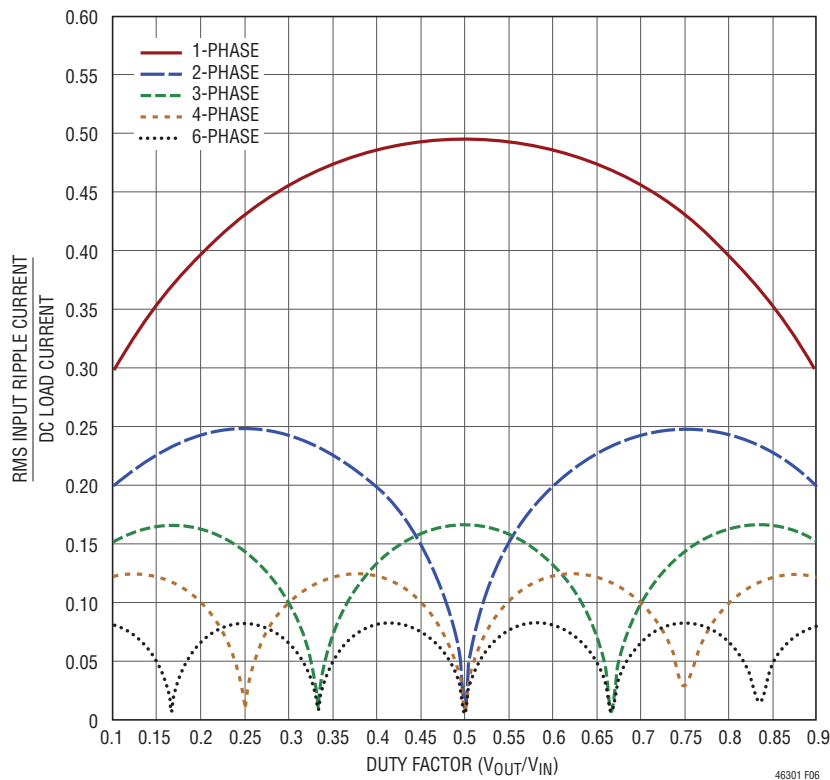

Figure 6. Input RMS Current Ratios to DC Load Current as a Function of Duty Cycle



## APPLICATIONS INFORMATION

### Frequency Selection and Phase-Lock Loop (MODE\_PLLIN and f<sub>SET</sub> Pins)

The LTM4630-1 device is operated over a range of frequencies to improve power conversion efficiency. It is recommended to operate the module at 500kHz over the output range for the best efficiency and inductor current ripple.

The LTM4630-1 switching frequency can be set with an external resistor from the f<sub>SET</sub> pin to SGND. An accurate 10μA current source into the resistor will set a voltage that programs the frequency or a DC voltage can be applied. Figure 7 shows a graph of frequency setting versus programming voltage. An external clock can be applied to the MODE\_PLLIN pin from 0V to INTV<sub>CC</sub> over a frequency range of 400kHz to 750kHz. The clock input high threshold is 1.6V and the clock input low threshold is 1V. The LTM4630-1 has the PLL loop filter components on board. The frequency setting resistor should always be present to set the initial switching frequency before locking to an external clock. Both regulators will operate in continuous mode while being externally clock.

The output of the PLL phase detector has a pair of complementary current sources that charge and discharge the internal filter network. When the external clock is

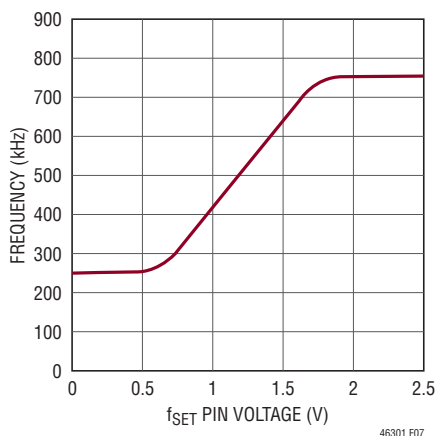

Figure 7. Operating Frequency vs f<sub>SET</sub> Pin Voltage

applied then the f<sub>SET</sub> frequency resistor is disconnected with an internal switch, and the current sources control the frequency adjustment to lock to the incoming external clock. When no external clock is applied, then the internal switch is on, thus connecting the external f<sub>SET</sub> frequency set resistor for free run operation.

### Minimum On-Time

Minimum on-time t<sub>ON</sub> is the smallest time duration that the LTM4630-1 is capable of turning on the top MOSFET on either channel. It is determined by internal timing delays, and the gate charge required to turning on the top MOSFET. Low duty cycle applications may approach this minimum on-time limit and care should be taken to ensure that:

$$\frac{V_{OUT}}{V_{IN} \cdot \text{FREQ}} > t_{ON(MIN)}$$

If the duty cycle falls below what can be accommodated by the minimum on-time, the controller will begin to skip cycles. The output voltage will continue to be regulated, but the output ripple and current will increase. The on-time can be increased by lowering the switching frequency. A good rule of thumb is to keep on-time longer than 110ns.

### Output Voltage Tracking

Output voltage tracking can be programmed externally using the TRACK pins. The output can be tracked up and down with another regulator. The main regulator's output is divided down with an external resistor divider that is the same as the subordinate regulator's feedback divider to implement coincident tracking. The LTM4630-1 uses an accurate 60.4k resistor internally for the top feedback resistor for each channel. Figure 8 shows an example of coincident tracking. Equation:

$$\text{SUBORDINATE} = \left( 1 + \frac{60.4k}{R_{TA}} \right) \cdot V_{TRACK}$$

V<sub>TRACK</sub> is the track ramp applied to the subordinate device's track pin. V<sub>TRACK</sub> has a control range of 0V

## APPLICATIONS INFORMATION

to 0.6V, or the internal reference voltage. When the main device's output is divided down with the same resistor values used to set the subordinate device's output, then the subordinate device will coincident track with the main device until it reaches its final value. The main device will continue to its final value from the subordinate device's regulation point. Voltage tracking is disabled when  $V_{\text{TRACK}}$  is more than 0.6V.  $R_{\text{TA}}$  in Figure 8 will be equal to the  $R_{\text{FB}}$  for coincident tracking. Figure 9 shows the coincident tracking waveforms.

The TRACK pin of the main device can be controlled by a capacitor placed on the main regulator TRACK pin to ground. A  $1.3\mu\text{A}$  current source will charge the TRACK pin up to the reference voltage and then proceed up to  $\text{INTV}_{\text{CC}}$ . After the 0.6V ramp, the TRACK pin will no longer be in control, and the internal voltage reference will control output regulation from the feedback divider. Foldback current limit is disabled during this sequence of turn-on during tracking or soft-starting. The TRACK pins are pulled low when the RUN pin is below 1.2V. The total soft-start time can be calculated as:

$$t_{\text{SOFT-START}} = \left( \frac{C_{\text{SS}}}{1.3\mu\text{A}} \right) \cdot 0.6$$

Regardless of the mode selected by the MODE\_PLLIN pin, the regulator channels will always start in pulse-skipping mode up to  $\text{TRACK} = 0.5\text{V}$ . Between  $\text{TRACK} = 0.5\text{V}$  and  $0.54\text{V}$ , it will operate in forced continuous mode and revert to the selected mode once  $\text{TRACK} > 0.54\text{V}$ . In order to track with another channel once in steady state operation, the LTM4630-1 is forced into continuous mode operation as soon as  $V_{\text{FB}}$  is below  $0.54\text{V}$  regardless of the setting on the MODE\_PLLIN pin.

Ratiometric tracking can be achieved by a few simple calculations and the slew rate value applied to the main device's TRACK pin. As mentioned above, the TRACK pin has a control range from 0 to 0.6V. The main device's TRACK pin slew rate is directly equal to the main device's output slew rate in Volts/Time. The equation:

$$\frac{\text{MR}}{\text{SR}} \cdot 60.4\text{k} = R_{\text{TB}}$$

where MR is the main device's output slew rate and SR is the subordinate device's output slew rate in Volts/Time. When coincident tracking is desired, then MR and SR are equal, thus  $R_{\text{TB}}$  is equal the 60.4k.  $R_{\text{TA}}$  is derived from equation:

$$R_{\text{TA}} = \frac{0.6\text{V}}{\frac{V_{\text{FB}}}{60.4\text{k}} + \frac{V_{\text{FB}}}{R_{\text{FB}}} - \frac{V_{\text{TRACK}}}{R_{\text{TB}}}}$$

where  $V_{\text{FB}}$  is the feedback voltage reference of the regulator, and  $V_{\text{TRACK}}$  is 0.6V. Since  $R_{\text{TB}}$  is equal to the 60.4k top feedback resistor of the subordinate regulator in equal slew rate or coincident tracking, then  $R_{\text{TA}}$  is equal to  $R_{\text{FB}}$  with  $V_{\text{FB}} = V_{\text{TRACK}}$ . Therefore  $R_{\text{TB}} = 60.4\text{k}$ , and  $R_{\text{TA}} = 60.4\text{k}$  in Figure 8.

In ratiometric tracking, a different slew rate maybe desired for the subordinate regulator.  $R_{\text{TB}}$  can be solved for when SR is slower than MR. Make sure that the subordinate supply slew rate is chosen to be fast enough so that the subordinate device output voltage will reach it final value before the main device output.

For example,  $\text{MR} = 1.5\text{V}/1\text{ms}$ , and  $\text{SR} = 1.2\text{V}/1\text{ms}$ . Then  $R_{\text{TB}} = 76.8\text{k}$ . Solve for  $R_{\text{TA}}$  to equal to 49.9k.

Each of the TRACK pins will have the  $1.3\mu\text{A}$  current source on when a resistive divider is used to implement tracking

# APPLICATIONS INFORMATION

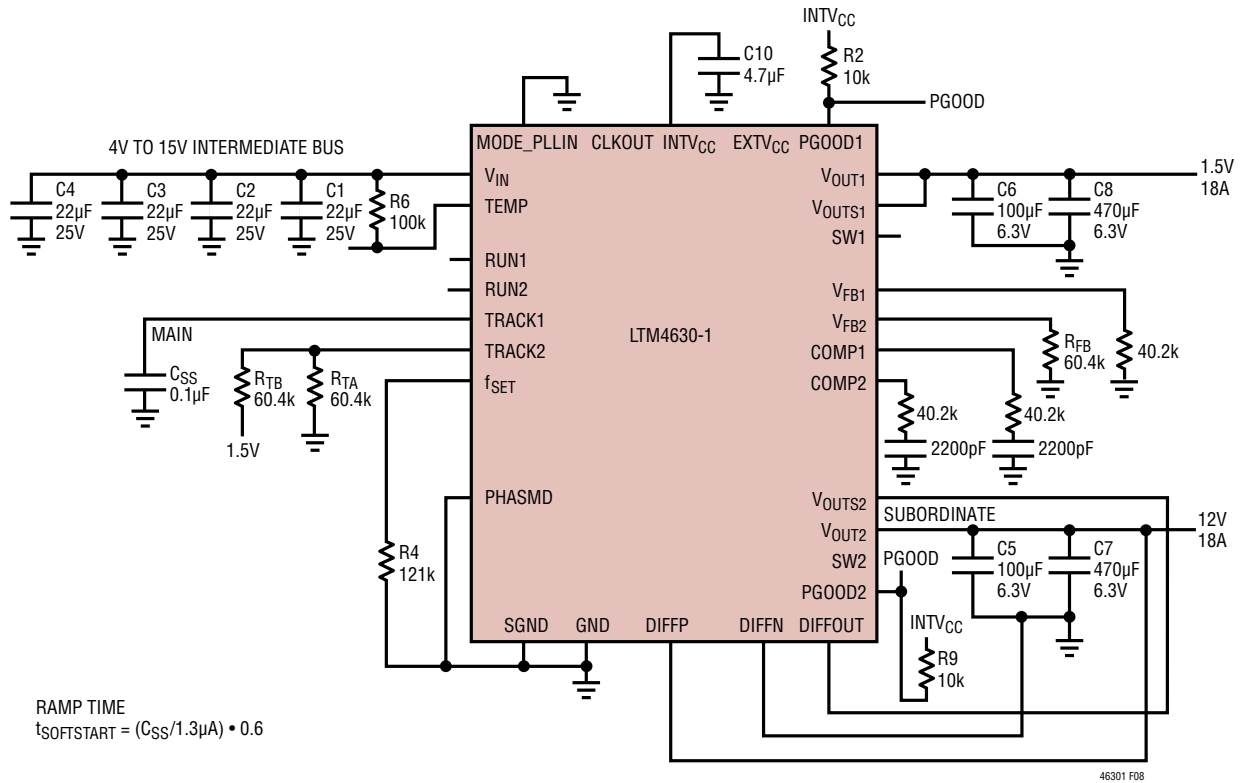

Figure 8. Example of Output Tracking Application Circuit

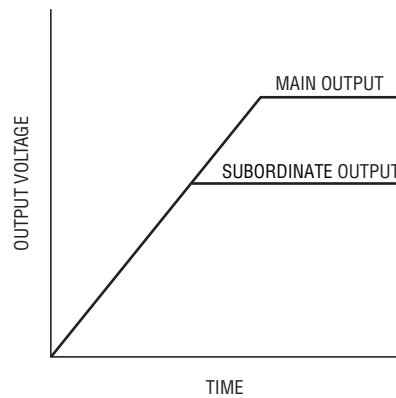

Figure 9. Output Coincident Tracking Waveform

## APPLICATIONS INFORMATION

on that specific channel. This will impose an offset on the TRACK pin input. Smaller values resistors with the same ratios as the resistor values calculated from the previous equation can be used. For example, where the 60.4k is used then a 6.04k can be used to reduce the TRACK pin offset to a negligible value.

### Power Good

The PGOOD pins are open-drain pins that can be used to monitor valid output voltage regulation. This pin monitors a 10% window around the regulation point. A resistor can be pulled up to a particular supply voltage no greater than 6V maximum for monitoring.

### Stability Compensation

The LTM4630-1 has a built-in 10pF high frequency filter capacitor from COMP to SGND on each output channel. An external RC filtering circuit is required to add from COMP to SGND to achieve fast Type II control loop compensation. Table 4 is provided for most application requirements. The Analog Devices  $\mu$ Module power design tool (LTpowerCAD) will be provided for other control loop optimization.

### Run Enable

The RUN pins have an enable threshold of 1.4V maximum, typically 1.25V with 150mV of hysteresis. They control the turn on each of the channels and INTV<sub>CC</sub>. These pins can be pulled up to V<sub>IN</sub> for 5V operation, or a 5V Zener diode can be placed on the pins and a 10k to 100k resistor can be placed up to higher than 5V input for enabling the channels. There is 1 $\mu$ A pull-up current for each RUN pin. The LTM4630-1 will turn on with RUN floating. Note that RUN has a 6V Abs Max voltage rating. The RUN pins can also be used for output voltage sequencing. In parallel operation, the RUN pins can be tied together and controlled from a single control. See the Typical Applications circuits in Figure 25.

### INTV<sub>CC</sub> and EXTV<sub>CC</sub>

The LTM4630-1 module has an internal 5V low dropout regulator that is derived from the input voltage. This regulator is used to power the control circuitry and the power MOSFET drivers. This regulator can source up to 70mA, and typically uses ~30mA for powering the device at the maximum frequency. This internal 5V supply is enabled by either RUN1 or RUN2 pins.

EXTV<sub>CC</sub> allows an external 5V supply to power the LTM4630-1 and reduces power dissipation from the internal low dropout 5V regulator. The power loss savings can be calculated by:

$$(V_{IN} - 5V) \cdot 30mA = PLOSS$$

EXTV<sub>CC</sub> has a threshold of 4.7V for activation, and a maximum rating of 6V. When using a 5V input, connect this 5V input to EXTV<sub>CC</sub> also to maintain a 5V gate drive level. EXTV<sub>CC</sub> must sequence on after V<sub>IN</sub>, and EXTV<sub>CC</sub> must sequence off before V<sub>IN</sub>.

### Differential Remote Sense Amplifier

An accurate differential remote sense amplifier is provided to sense low output voltages accurately at the remote load points. This is especially true for high current loads. The amplifier can be used on one of the two channels, or on a single parallel output. It is very important that the DIFFP and DIFFN are connected properly at the output, and DIFFOUT is connected to either V<sub>OUTS1</sub> or V<sub>OUTS2</sub>. In parallel operation, the DIFFP and DIFFN are connected properly at the output, and DIFFOUT is connected to one of the V<sub>OUTS</sub> pins. See the parallel schematics in Figure 26 and Figure 4.

### SW Pins

The SW pins are generally for testing purposes by monitoring these pins. These pins can also be used to dampen out switch node ringing caused by LC parasitic in the switched current paths. Usually a series R-C combination

## APPLICATIONS INFORMATION

is used called a snubber circuit. The resistor will dampen the resonance and the capacitor is chosen to only affect the high frequency ringing across the resistor. If the stray inductance or capacitance can be measured or approximated, then a somewhat analytical technique can be used to select the snubber values. The inductance is usually easier to predict. It combines the power path board inductance in combination with the MOSFET interconnect bond wire inductance.

First the SW pin can be monitored with a wide bandwidth scope with a high frequency scope probe. The ring frequency can be measured for its value. The impedance Z can be calculated:

$$Z_{(L)} = 2\pi fL,$$

where f is the resonant frequency of the ring, and L is the total parasitic inductance in the switch path. If a resistor is selected that is equal to Z, then the ringing should be dampened. The snubber capacitor value is chosen so that its impedance is equal to the resistor at the ring frequency. Calculated by:  $Z_{(C)} = 1/(2\pi fC)$ . These values are a good place to start with. Modification to these components should be made to attenuate the ringing with the least amount of power loss.

### Temperature Monitoring

A diode connected PNP transistor is used for the TEMP monitor function by monitoring its voltage over temperature. The temperature dependence of this diode voltage can be understood in the equation:

$$V_D = nV_T \ln\left(\frac{I_D}{I_S}\right)$$

where  $V_T$  is the thermal voltage ( $kT/q$ ), and n, the ideality factor, is 1 for the diode connected PNP transistor being used in the LTM4630.  $I_S$  is expressed by the typical empirical equation:

$$I_S = I_0 \exp\left(\frac{-V_{G0}}{V_T}\right)$$

where  $I_0$  is a process and geometry dependent current, ( $I_0$  is typically around 20k orders of magnitude larger than  $I_S$  at room temperature) and  $V_{G0}$  is the band gap voltage of 1.2V extrapolated to absolute zero or  $-273^\circ\text{C}$ .

If we take the  $I_S$  equation and substitute into the  $V_D$  equation, then we get:

$$V_D = V_{G0} - \left(\frac{kT}{q}\right) \ln\left(\frac{I_0}{I_D}\right), \quad V_T = \frac{kT}{q}$$

The expression shows that the diode voltage decreases (linearly if  $I_0$  were constant) with increasing temperature and constant diode current. Figure 10 shows a plot of  $V_D$  vs Temperature over the operating temperature range of the LTM4630-1.

If we take this equation and differentiate it with respect to temperature T, then:

$$\frac{dV_D}{dT} = -\frac{V_{G0} - V_D}{T}$$

This  $dV_D/dT$  term is the temperature coefficient equal to about  $-2\text{mV/K}$  or  $-2\text{mV}/^\circ\text{C}$ . The equation is simplified for the first order derivation.

Solving for T,  $T = -(V_{G0} - V_D)/(dV_D/dT)$  provides the temperature.

1st Example: Figure 10 for  $27^\circ\text{C}$ , or 300K the diode voltage is 0.598V, thus,  $300\text{K} = -(1200\text{mV} - 598\text{mV})/(-2.0\text{ mV/K})$

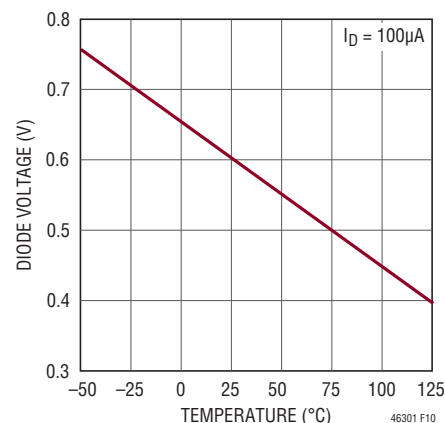

Figure 10. Diode Voltage  $V_D$  vs Temperature T(K) for Different Bias Currents

## APPLICATIONS INFORMATION

2nd Example: Figure 10 for 75°C, or 350K the diode voltage is 0.50V, thus,  $350K = -(1200mV - 500mV)/-2.0mV/K$

Converting the Kelvin scale to Celsius is simply taking the Kelvin temp and subtracting 273 from it.

A typical forward voltage is given in the Electrical Characteristics section, and Figure 10 is the plot of this forward voltage. Measure this forward voltage at 27°C to establish a reference point. Then using the above expression while measuring the forward voltage over temperature will provide a general temperature monitor. Connect a resistor between TEMP and  $V_{IN}$  to set the current to 100μA. See Figure 26 for an example.

### Thermal Considerations and Output Current Derating

The thermal resistances reported in the Pin Configuration section are consistent with those parameters defined by JESD51-9 and are intended for use with finite element analysis (FEA) software modeling tools that leverage the outcome of thermal modeling, simulation, and correlation to hardware evaluation performed on a μModule package mounted to a hardware test board—also defined by JESD51-9 (“Test Boards for Area Array Surface Mount Package Thermal Measurements”). The motivation for providing these thermal coefficients is found in JESD 51-12 (“Guidelines for Reporting and Using Electronic Package Thermal Information”).

Many designers may opt to use laboratory equipment and a test vehicle such as the demo board to anticipate the μModule regulator’s thermal performance in their application at various electrical and environmental operating conditions to compliment any FEA activities. Without FEA software, the thermal resistances reported in the Pin Configuration section are in-and-of themselves not relevant to providing guidance of thermal performance; instead, the derating curves provided in the data sheet can be used in a manner that yields insight and guidance pertaining to one’s application-usage, and can be adapted to correlate thermal performance to one’s own application.

The Pin Configuration section typically gives four thermal coefficients explicitly defined in JESD 51-12; these coefficients are quoted or paraphrased below.

1.  $\theta_{JA}$ , the thermal resistance from junction to ambient, is the natural convection junction-to-ambient air thermal resistance measured in a one cubic foot sealed enclosure. This environment is sometimes referred to as “still air” although natural convection causes the air to move. This value is determined with the part mounted to a JESD 51-9 defined test board, which does not reflect an actual application or viable operating condition.
2.  $\theta_{JCbottom}$ , the thermal resistance from junction to the bottom of the product case, is the junction-to-board thermal resistance with all of the component power dissipation flowing through the bottom of the package. In the typical μModule, the bulk of the heat flows out the bottom of the package, but there is always heat flow out into the ambient environment. As a result, this thermal resistance value may be useful for comparing packages but the test conditions don’t generally match the user’s application.
3.  $\theta_{JCTop}$ , the thermal resistance from junction to top of the product case, is determined with nearly all of the component power dissipation flowing through the top of the package. As the electrical connections of the typical μModule are on the bottom of the package, it is rare for an application to operate such that most of the heat flows from the junction to the top of the part. As in the case of  $\theta_{JCbottom}$ , this value may be useful for comparing packages but the test conditions do not generally match the user’s application.
4.  $\theta_{JB}$ , the thermal resistance from junction to the printed circuit board, is the junction-to-board thermal resistance where almost all of the heat flows through the bottom of the μModule and into the board, and is really the sum of the  $\theta_{JCbottom}$  and the thermal resistance of the bottom of the part through the solder joints and through a portion of the board. The board temperature is measured a specified distance from the package, using a two sided, two layer board. This board is described in JESD 51-9.

A graphical representation of the aforementioned thermal resistances is given in Figure 11; blue resistances are

## APPLICATIONS INFORMATION

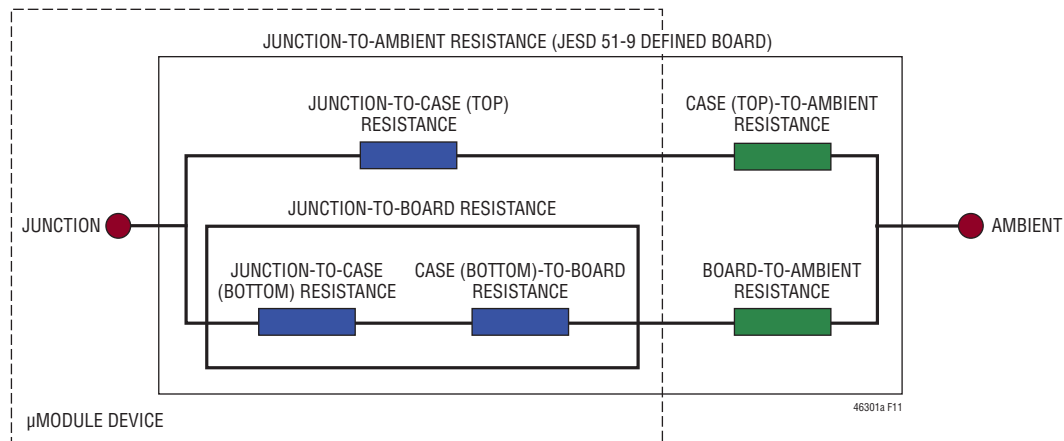

**Figure 11. Graphical Representation of JESD51-12 Thermal Coefficients**

contained within the  $\mu$ Module regulator, whereas green resistances are external to the  $\mu$ Module.

As a practical matter, it should be clear to the reader that no individual or sub-group of the four thermal resistance parameters defined by JESD 51-12 or provided in the Pin Configuration section replicates or conveys normal operating conditions of a  $\mu$ Module. For example, in normal board-mounted applications, never does 100% of the device's total power loss (heat) thermally conduct exclusively through the top or exclusively through bottom of the  $\mu$ Module—as the standard defines for  $\theta_{JCtop}$  and  $\theta_{JCbottom}$ , respectively. In practice, power loss is thermally dissipated in both directions away from the package—granted, in the absence of a heat sink and airflow, a majority of the heat flow is into the board.

Within a SIP (system-in-package) module, be aware there are multiple power devices and components dissipating power, with a consequence that the thermal resistances relative to different junctions of components or die are not exactly linear with respect to total package power loss. To reconcile this complication without sacrificing modeling simplicity—but also, not ignoring practical realities—an approach has been taken using FEA software modeling along with laboratory testing in a controlled-environment chamber to reasonably define and correlate the thermal resistance values supplied in this data sheet: (1) Initially,

FEA software is used to accurately build the mechanical geometry of the  $\mu$ Module and the specified PCB with all of the correct material coefficients along with accurate power loss source definitions; (2) this model simulates a software-defined JEDEC environment consistent with JESD51-9 to predict power loss heat flow and temperature readings at different interfaces that enable the calculation of the JEDEC-defined thermal resistance values; (3) the model and FEA software is used to evaluate the  $\mu$ Module with heat sink and airflow; (4) having solved for and analyzed these thermal resistance values and simulated various operating conditions in the software model, a thorough laboratory evaluation replicates the simulated conditions with thermocouples within a controlled-environment chamber while operating the device at the same power loss as that which was simulated. An outcome of this process and due-diligence yields a set of derating curves provided in other sections of this data sheet. After these laboratory test have been performed and correlated to the  $\mu$ Module model, then the  $\theta_{JB}$  and  $\theta_{BA}$  are summed together to correlate quite well with the  $\mu$ Module model with no airflow or heat sinking in a properly define chamber. This  $\theta_{JB} + \theta_{BA}$  value is shown in the Pin Configuration section and should accurately equal the  $\theta_{JA}$  value because approximately 100% of power loss flows from the junction through the board into ambient with no airflow or

## APPLICATIONS INFORMATION

top mounted heat sink. Each system has its own thermal characteristics; therefore, thermal analysis must be performed by the user in a particular system.

The LTM4630-1 module has been designed to effectively remove heat from both the top and bottom of the package. The bottom substrate material has very low thermal resistance to the printed circuit board. An external heat sink can be applied to the top of the device for excellent heat sinking with airflow.

Figure 12 and Figure 13 show temperature plots of the LTM4630-1 with no heat sink and 200LFM airflow.

These plots equate to a paralleled 12V to 1.0V at 36A design operating at 87.5% efficiency, and 12V to 1.5V at 36A design operating at 90.5% efficiency.

### Safety Considerations

The LTM4630-1 modules do not provide isolation from  $V_{IN}$  to  $V_{OUT}$ . There is no internal fuse. If required, a slow blow fuse with a rating twice the maximum input current needs to be provided to protect each unit from catastrophic failure. The device does support over current protection. A temperature diode is provided for monitoring internal temperature, and can be used to detect the need for thermal shutdown that can be done by controlling the RUN pin.

### Power Derating

The 1.0V and 1.5V power loss curves in Figure 15 and Figure 16 can be used in coordination with the load current derating curves in Figure 17 to Figure 24 for calculating an approximate  $\theta_{JA}$  thermal resistance for the LTM4630-1 with various heat sinking and airflow conditions. The power loss curves are taken at room temperature, and are increased with a 1.35 to 1.4 multiplicative factor at 125°C. These factors come from the fact that the power loss of the regulator increases about 45% from 25°C to 150°C, thus a 50% spread over 125°C delta equates to ~0.35%/°C loss increase. A 125°C maximum junction minus 25°C room temperature equates to a 100°C increase. This 100°C increase multiplied by 0.35%/°C equals a 35% power loss increase at the 125°C junction, thus the 1.35 multiplier.

The derating curves are plotted with CH1 and CH2 in parallel single output operation starting at 36A of load with low ambient temperature. The output voltages are 1.0V and 1.5V. These are chosen to include the lower and higher output voltage ranges for correlating the thermal resistance. Thermal models are derived from several temperature measurements in a controlled temperature chamber along with thermal modeling analysis.

The junction temperatures are monitored while ambient temperature is increased with and without airflow. The

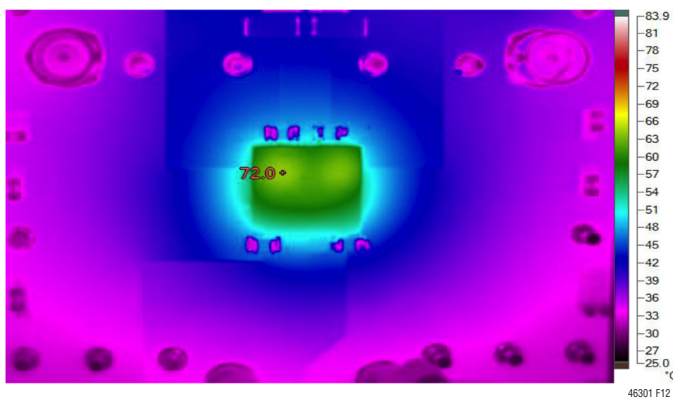

Figure 12. Thermal Image 12V to 1.0V, 36A with 200LFM Airflow without Heat Sink

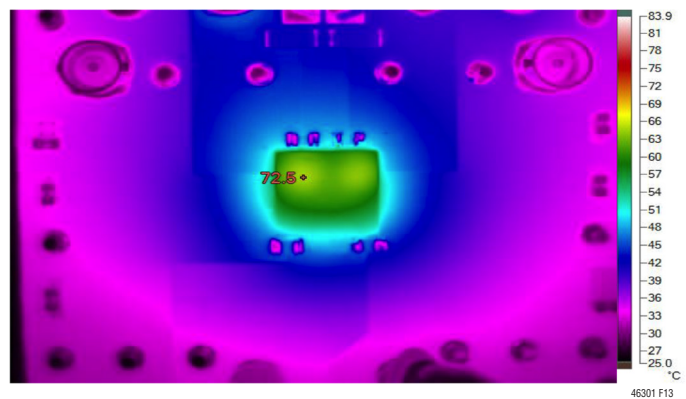

Figure 13. Thermal Image 12V to 1.5V, 36A with 200LFM Airflow without Heat Sink



## APPLICATIONS INFORMATION

power loss increase with ambient temperature change is factored into the derating curves. The junctions are maintained at  $\sim 120^{\circ}\text{C}$  maximum while lowering output current or power while increasing ambient temperature. The decreased output current will decrease the internal module loss as ambient temperature is increased.

The monitored junction temperature of  $120^{\circ}\text{C}$  minus the ambient operating temperature specifies how much module temperature rise can be allowed. As an example in Figure 18, the load current is derated to  $\sim 20\text{A}$  at  $\sim 100^{\circ}\text{C}$  with no air or heat sink and the power loss for the 5V to 1.0V at 20A output is a  $\sim 2.6\text{W}$  loss. The 2.6W loss is calculated with the  $\sim 1.9\text{W}$  room temperature loss from the 5V to 1.0V power loss curve at 20A, and the 1.35 multiplying factor at  $120^{\circ}\text{C}$  junction. If the  $100^{\circ}\text{C}$  ambient temperature is subtracted from the  $120^{\circ}\text{C}$  junction temperature, then the difference of  $20^{\circ}\text{C}$  divided 2.6W equals a  $7.7^{\circ}\text{C}/\text{W}$   $\theta_{\text{JA}}$  thermal resistance. Table 2 specifies a  $8^{\circ}\text{C}/\text{W}$  value which is pretty close. The airflow graphs are more accurate due to the fact that the ambient temperature environment is controlled better with airflow. As an example in Figure 19, the load current is derated to  $\sim 30\text{A}$  at  $\sim 90^{\circ}\text{C}$  with 200LFM of airflow and BGD heat sink. The power loss for the 12V to 1.0V at 30A output is a  $\sim 5.7\text{W}$  loss. The 5.7W loss is calculated with the  $\sim 4.2\text{W}$  room temperature loss from the 12V to 1.0V power loss curve at 30A, and the 1.35 multiplying factor at  $120^{\circ}\text{C}$  junction. If the  $90^{\circ}\text{C}$  ambient temperature is subtracted from the  $120^{\circ}\text{C}$  junction temperature, then the difference of  $30^{\circ}\text{C}$  divided 5.7W equals a  $5.2^{\circ}\text{C}/\text{W}$   $\theta_{\text{JA}}$  thermal resistance. Table 2 specifies a  $5.0^{\circ}\text{C}/\text{W}$  value which is pretty close. Table 2 and Table 3 provide equivalent thermal resistances for 1.0V and 1.5V outputs with and without airflow and heat sinking.

The derived thermal resistances in Table 2 and Table 3 for the various conditions can be multiplied by the calculated power loss as a function of ambient temperature to derive temperature rise above ambient, thus maximum junction temperature. Room temperature power loss can

be derived from the efficiency curves and adjusted with the above ambient temperature multiplicative factors. The printed circuit board is a 1.6mm thick four layer board with two ounce copper for the two outer layers and one ounce copper for the two inner layers. The PCB dimensions are  $101\text{mm} \times 114\text{mm}$ . The BGA heat sinks are listed in Table 3.

### Layout Checklist/Example

The high integration of LTM4630-1 makes the PCB board layout very simple and easy. However, to optimize its electrical and thermal performance, some layout considerations are still necessary.

- Use large PCB copper areas for high current paths, including  $V_{\text{IN}}$ , GND,  $V_{\text{OUT1}}$ , and  $V_{\text{OUT2}}$ . It helps to minimize the PCB conduction loss and thermal stress.
- Place high frequency ceramic input and output capacitors next to the  $V_{\text{IN}}$ , PGND and  $V_{\text{OUT}}$  pins to minimize high frequency noise.
- Place a dedicated power ground layer underneath the unit.
- To minimize the via conduction loss and reduce module thermal stress, use multiple vias for interconnection between top layer and other power layers.
- Do not put via directly on the pad, unless they are capped or plated over.
- Use a separated SGND ground copper area for components connected to signal pins. Connect the SGND to GND underneath the unit.
- For parallel modules, tie the  $V_{\text{OUT}}$ ,  $V_{\text{FB}}$ , and COMP pins together. Use an internal layer to closely connect these pins together. The TRACK pin can be tied a common capacitor for regulator soft-start.
- Bring out test points on the signal pins for monitoring.

Figure 14 gives a good example of the recommended layout.

## APPLICATIONS INFORMATION

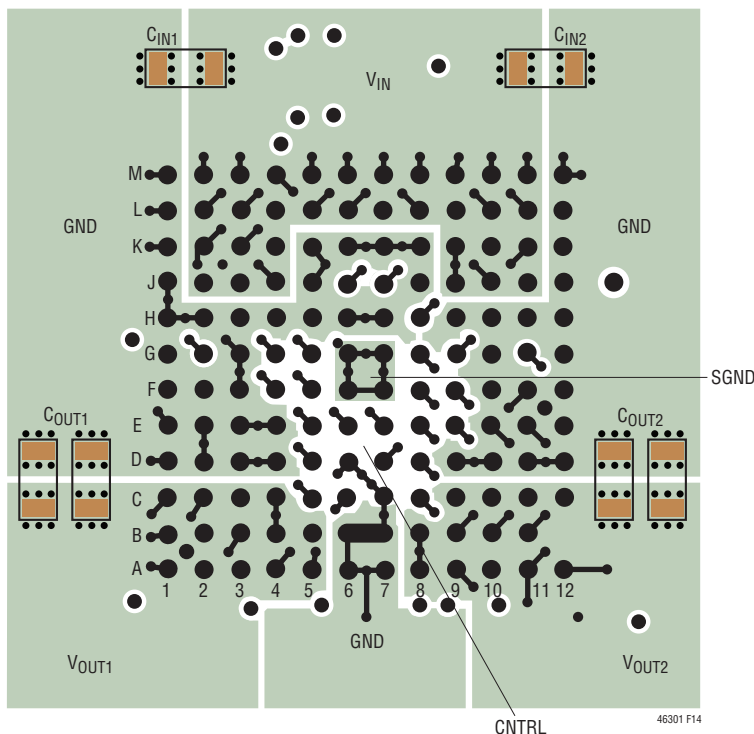

Figure 14. Recommended PCB Layout

Table 2. 1.0V Output

DERATING CURVE	V <sub>IN</sub> (V)	POWER LOSS CURVE	AIRFLOW (LFM)	HEAT SINK	θ <sub>JA</sub> (°C/W)
Figures 17, 18	5, 12	Figure 15	0	None	8
Figures 17, 18	5, 12	Figure 15	200	None	6
Figures 17, 18	5, 12	Figure 15	400	None	5.5
Figures 19, 20	5, 12	Figure 15	0	BGA Heat Sink	7
Figures 19, 20	5, 12	Figure 15	200	BGA Heat Sink	5
Figures 19, 20	5, 12	Figure 15	400	BGA Heat Sink	4.5

Table 3. 1.5V Output

DERATING CURVE	V <sub>IN</sub> (V)	POWER LOSS CURVE	AIRFLOW (LFM)	HEAT SINK	θ <sub>JA</sub> (°C/W)
Figures 21, 22	5, 12	Figure 16	0	None	8
Figures 21, 22	5, 12	Figure 16	200	None	6
Figures 21, 22	5, 12	Figure 16	400	None	5.5
Figures 23, 24	5, 12	Figure 16	0	BGA Heat Sink	7
Figures 23, 24	5, 12	Figure 16	200	BGA Heat Sink	5
Figures 23, 24	5, 12	Figure 16	400	BGA Heat Sink	4.5

HEAT SINK MANUFACTURER	PART NUMBER	WEBSITE
Aavid Thermalloy	375424B00034G	www.aavid.com

## APPLICATIONS INFORMATION

**Table 4. Output Voltage Response vs Component Matrix (Refer to Figure 26) Load Step Typical Measured Values**

### 2-Phase Single Output Solution

C <sub>IN</sub> (CERAMIC)			C <sub>OUT</sub> (CERAMIC)			C <sub>OUT</sub> (BULK)		
VENDORS	VALUE	PART NUMBER	VENDORS	VALUE	PART NUMBER	VENDORS	VALUE	PART NUMBER
MURATA	22 $\mu$ F, 16V, X5R, 1210	GRM32ER61C226KE20L	MURATA	100 $\mu$ F, 6.3V, X5R, 1210	GRM32ER60J107ME20L	SANYO	680 $\mu$ F, 2.5V, 6m $\Omega$	2R5TPF680M6L
MURATA	22 $\mu$ F, 16V, X5R, 1206	GRM31CR61C226KE15K	MURATA	220 $\mu$ F, 4V, X5R, 1206	GRM31CR60G227M			
TDK	22 $\mu$ F, 16V, X5R, 1210	C3225X5R1C226M250AA	TAIYO YUDEN	100 $\mu$ F, 6.3V, X5R, 1210	JMK325BJ107MM-T			
			TAIYO YUDEN	220 $\mu$ F, 4V, X5R, 1210	AMK325ABJ227MM-T			

### 25% Load Step (0A to 9A) Ceramic Output Capacitor Only Solutions

PK-PK DEVIATION PERCENTAGE	V <sub>IN</sub> (V)	V <sub>OUT</sub> (V)	C <sub>IN</sub> * BULK ( $\mu$ F)	C <sub>IN</sub> CERAMIC ( $\mu$ F)	C <sub>OUT</sub> BULK ( $\mu$ F)	C <sub>OUT</sub> CERAMIC ( $\mu$ F)	COMP PIN RESISTOR R <sub>TH</sub> (k $\Omega$ )	COMP PIN CAPACITOR C <sub>TH</sub> (pF)	FEED-FORWARD CAPACITOR C <sub>FF</sub> (pF)	PK-PK DEVIATION V <sub>PK-PK</sub> (mV)	SETTLING TIME t <sub>SETTLE</sub> ( $\mu$ s)	CTRL LOOP BANDWIDTH BW (kHz)	CTRL LOOP PHASE MARGIN PM (Deg)	LOAD STEP (A)	LOAD STEP SLEW RATE (A/ $\mu$ s)	RFB (k $\Omega$ )	FREQ (kHz)
$\pm$ 3% (<54mV)	12	0.9	150	22 $\times$ 2	None	100 $\times$ 12	4.22	2200	33	48	30	82	50	9	10	120.8	450
$\pm$ 3% (<60mV)	12	1	150	22 $\times$ 2	None	100 $\times$ 12	4.22	2200	33	56	30	81	50	9	10	90.9	450
$\pm$ 3% (<72mV)	12	1.2	150	22 $\times$ 2	None	100 $\times$ 10	3.74	2200	33	66	30	81	51	9	10	60.4	450
$\pm$ 3% (<90mV)	12	1.5	150	22 $\times$ 2	None	100 $\times$ 8	4.01	2200	33	83	40	83	50	9	10	40.2	450
$\pm$ 3% (<108mV)	12	1.8	150	22 $\times$ 2	None	100 $\times$ 7	4.12	2200	33	94	50	81	53	9	10	30.2	450
$\pm$ 3% (<54mV)	12	0.9	150	22 $\times$ 2	None	220 $\times$ 6	5.76	3300	33	45	50	80	63	9	10	120.8	450
$\pm$ 3% (<60mV)	12	1	150	22 $\times$ 2	None	220 $\times$ 6	5.76	3300	33	52	50	80	61	9	10	90.9	450
$\pm$ 3% (<72mV)	12	1.2	150	22 $\times$ 2	None	220 $\times$ 5	4.64	2200	33	65	50	81	61	9	10	60.4	450
$\pm$ 3% (<90mV)	12	1.5	150	22 $\times$ 2	None	220 $\times$ 4	4.22	2200	33	84	50	81	53	9	10	40.2	450
$\pm$ 3% (<108mV)	12	1.8	150	22 $\times$ 2	None	220 $\times$ 4	4.53	2200	33	95	50	81	54	9	10	30.2	450

### 25% Load Step (0A to 9A) Bulk + Ceramic Output Capacitor Solutions

$\pm$ 3% (<54mV)	12	0.9	150	22 $\times$ 2	680 $\times$ 2	100 $\times$ 7	3.65	1500	None	53	30	60	60	9	10	120.8	450
$\pm$ 3% (<60mV)	12	1	150	22 $\times$ 2	680 $\times$ 2	100 $\times$ 7	3.65	1500	None	60	30	60	59	9	10	90.9	450
$\pm$ 3% (<72mV)	12	1.2	150	22 $\times$ 2	680 $\times$ 2	100 $\times$ 4	4.33	1500	None	68	30	63	68	9	10	60.4	450
$\pm$ 3% (<90mV)	12	1.5	150	22 $\times$ 2	680 $\times$ 2	100 $\times$ 2	6.98	1500	None	83	30	81	62	9	10	40.2	450
$\pm$ 3% (<108mV)	12	1.8	150	22 $\times$ 2	680 $\times$ 2	100 $\times$ 1	8.45	1500	None	96	30	80	64	9	10	30.2	450

## APPLICATIONS INFORMATION

C <sub>IN</sub> (CERAMIC)			C <sub>OUT</sub> (CERAMIC)			C <sub>OUT</sub> (BULK)		
VENDORS	VALUE	PART NUMBER	VENDORS	VALUE	PART NUMBER	VENDORS	VALUE	PART NUMBER
MURATA	22μF, 16V, X5R, 1210	GRM32ER61C226KE20L	MURATA	100μF, 6.3V, X5R, 1210	GRM32ER60J107ME20L	SANYO	680μF, 2.5V, 6mΩ	2R5TPF680M6L
MURATA	22μF, 16V, X5R, 1206	GRM31CR61C226KE15K	MURATA	220μF, 4V, X5R, 1206	GRM31CR60G227M			
TDK	22μF, 16V, X5R, 1210	C3225X5R1C226M250AA	TAIYO YUDEN	100μF, 6.3V, X5R, 1210	JMK325BJ107MM-T			
			TAIYO YUDEN	220μF, 4V, X5R, 1210	AMK325ABJ227MM-T			

## 50% Load Step (0A to 18A), Ceramic Output Capacitor Only Solutions

PK-PK DEVIATION PERCENTAGE	V <sub>IN</sub> (V)	V <sub>OUT</sub> (V)	C <sub>IN</sub> * BULK (μF)	C <sub>IN</sub> CERAMIC (μF)	C <sub>OUT</sub> BULK (μF)	C <sub>OUT</sub> CERAMIC (μF)	COMP PIN RESISTOR R <sub>TH</sub> (kΩ)	COMP PIN CAPACITOR C <sub>TH</sub> (pF)	FEED-FORWARD CAPACITOR C <sub>FF</sub> (pF)	PK-PK DEVIATION V <sub>PK-PK</sub> (mV)	SETTLING TIME t <sub>SETTLE</sub> (μs)	CTRL LOOP BANDWIDTH BW (kHz)	CTRL LOOP PHASE MARGIN PM (Deg)	LOAD STEP (A)	LOAD STEP SLEW RATE (A/μs)	RFB (kΩ)	FREQ (kHz)
±3% (<54mV)	12	0.9	150	22 ×2	None	100 ×24	6.98	3300	100	52	80	70	65	18	10	120.8	450
±3% (<60mV)	12	1	150	22 ×2	None	100 ×23	8.06	3300	100	58	80	80	63	18	10	90.9	450
±3% (<72mV)	12	1.2	150	22 ×2	None	100 ×20	6.19	3300	100	67	80	82	63	18	10	60.4	450
±3% (<90mV)	12	1.5	150	22 ×2	None	100 ×16	4.32	3300	100	88	80	70	68	18	10	40.2	450
±3% (<108mV)	12	1.8	150	22 ×2	None	100 ×14	4.12	3300	100	101	80	70	72	18	10	30.2	450
±3% (<54mV)	12	0.9	150	22 ×2	None	220 ×9	7.68	3300	100	52	80	70	68	18	10	120.8	450
±3% (<60mV)	12	1	150	22 ×2	None	220 ×9	6.81	3300	100	58	80	70	67	18	10	90.9	450
±3% (<72mV)	12	1.2	150	22 ×2	None	220 ×7	5.11	3300	100	71	80	80	64	18	10	60.4	450
±3% (<90mV)	12	1.5	150	22 ×2	None	220 ×7	5.11	3300	100	85	80	81	65	18	10	40.2	450
±3% (<108mV)	12	1.8	150	22 ×2	None	220 ×6	4.99	3300	100	101	80	81	67	18	10	30.2	450

## 50% Load Step (0A to 18A), Bulk + Ceramic Output Capacitor Solutions

±3% (<54mV)	12	0.9	150	22 ×2	680 ×2	100 ×14	5.76	2200	47	53	40	61	84	18	10	120.8	450
±3% (<60mV)	12	1	150	22 ×2	680 ×2	100 ×12	6.04	2200	47	60	40	70	86	18	10	90.9	450
±3% (<72mV)	12	1.2	150	22 ×2	680 ×2	100 ×6	4.99	2200	47	68	40	80	88	18	10	60.4	450
±3% (<90mV)	12	1.5	150	22 ×2	680 ×2	100 ×4	6.98	1500	47	90	30	81	95	18	10	40.2	450
±3% (<108mV)	12	1.8	150	22 ×2	680 ×2	100 ×2	4.94	1000	47	101	25	80	96	18	10	30.2	450

# APPLICATIONS INFORMATION

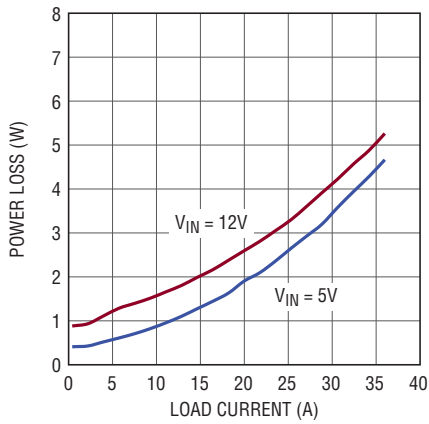

Figure 15. 1.0V Power Loss Curve

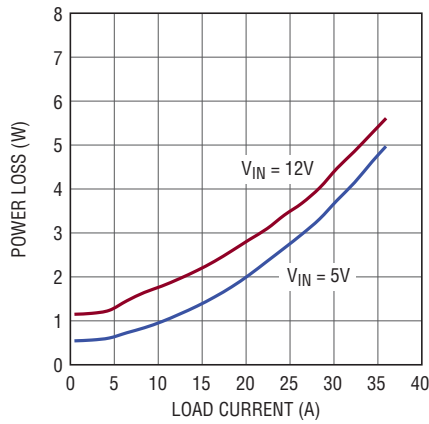

Figure 16. 1.5V Power Loss Curve

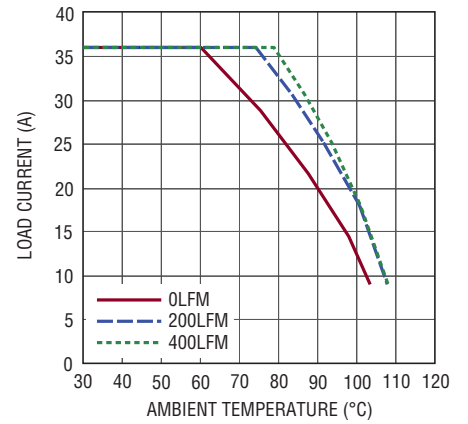

Figure 17. 12V to 1V Derating Curve, No Heat Sink

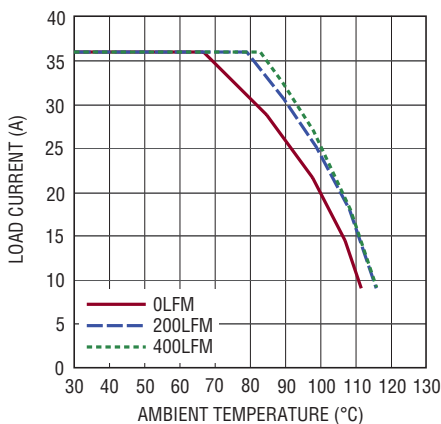

Figure 18. 5V to 1V Derating Curve, No Heat Sink

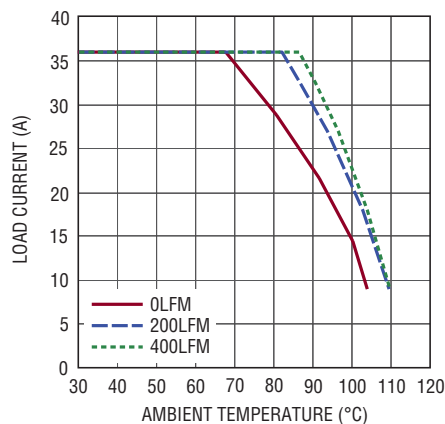

Figure 19. 12V to 1V Derating Curve, BGA Heat Sink

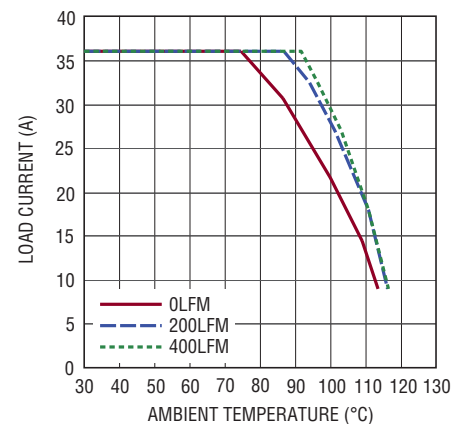

Figure 20. 5V to 1V Derating Curve, BGA Heat Sink

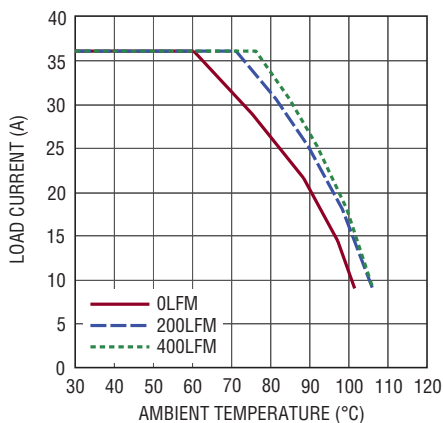

Figure 21. 12V to 1.5V Derating Curve, No Heat Sink

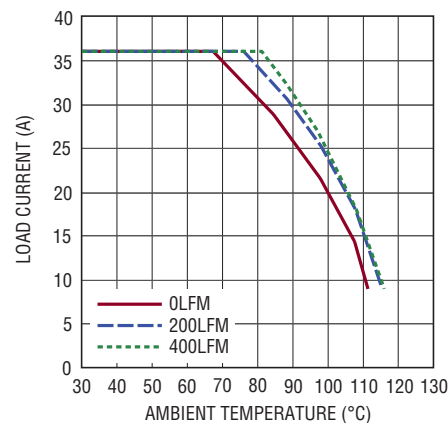
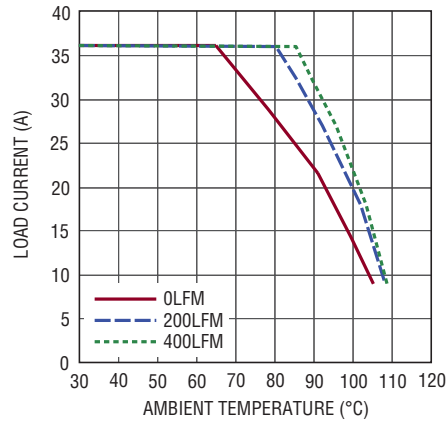

Figure 22. 5V to 1.5V Derating Curve, No Heat Sink

**APPLICATIONS INFORMATION**



46301 F23

**Figure 23. 12V to 1.5V Derating Curve, BGA Heat Sink**

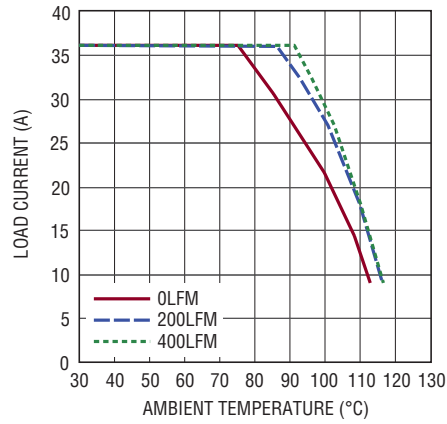

46301 F24

**Figure 24. 5V to 1.5V Derating Curve, BGA Heat Sink**

TYPICAL APPLICATIONS

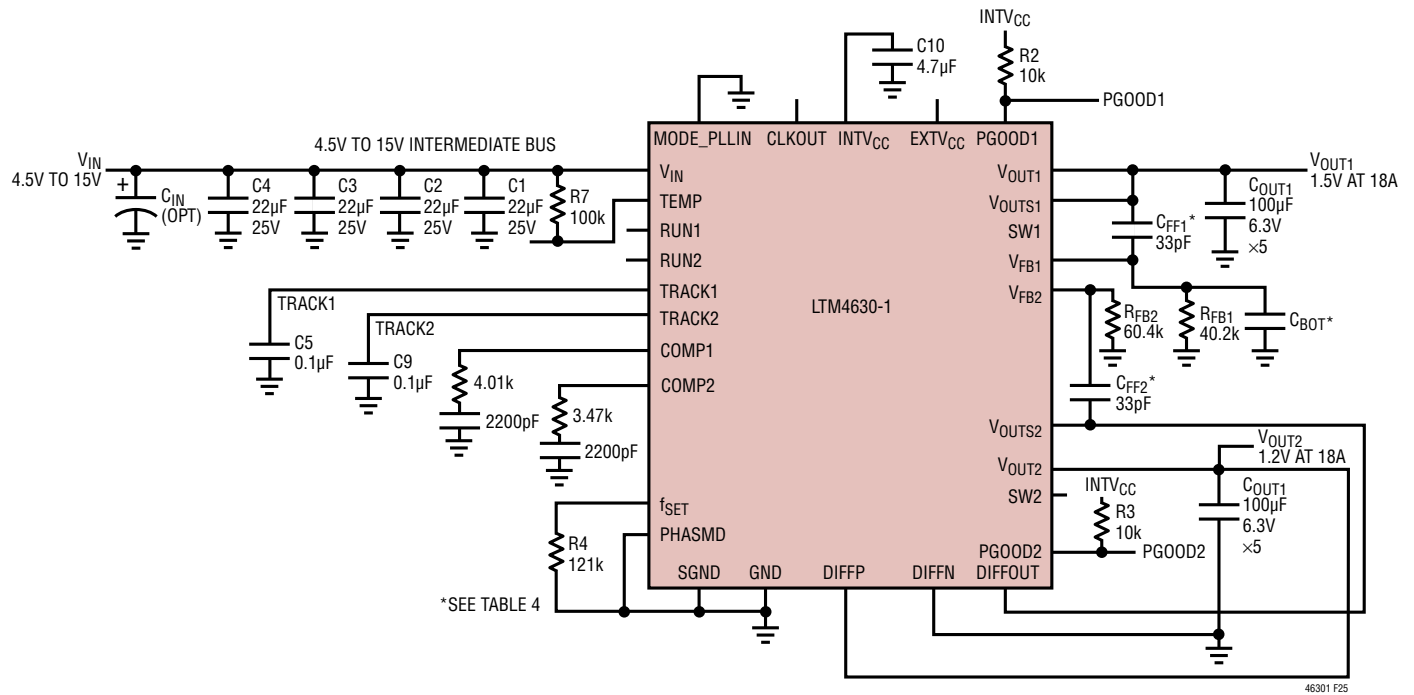
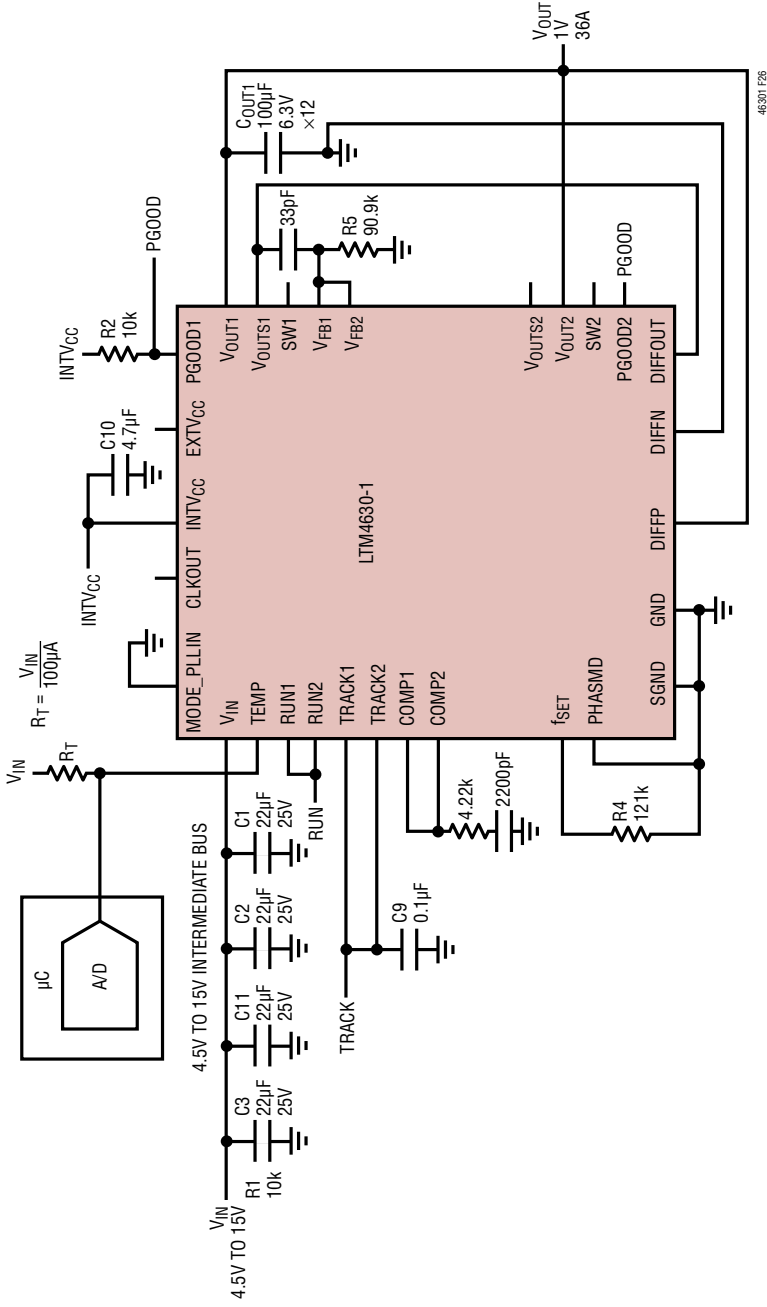
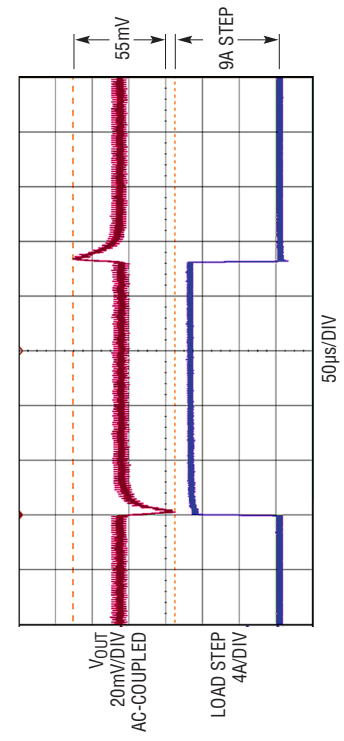

Figure 25. Typical 4.5VIN to 15VIN, 1.5V and 1.2V at 18A Outputs

TYPICAL APPLICATIONS



25% Load Step Transient Response ±3% Output Regulation Window. 12VIN, 1.0VOUT, 36A per Above Circuit



12VIN, 1.0VOUT, 36A Bode Plot per Above Circuit

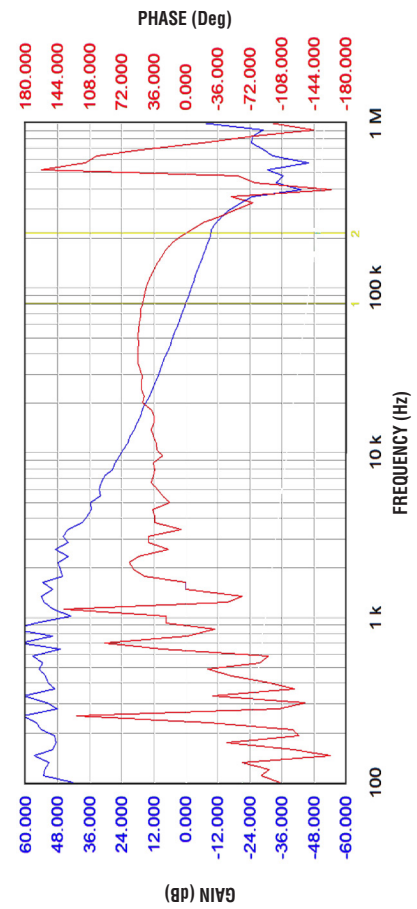

Figure 26. LTM4630-1 2-Phase, 1V at 36A Design with ±3% Transient Response



TYPICAL APPLICATIONS

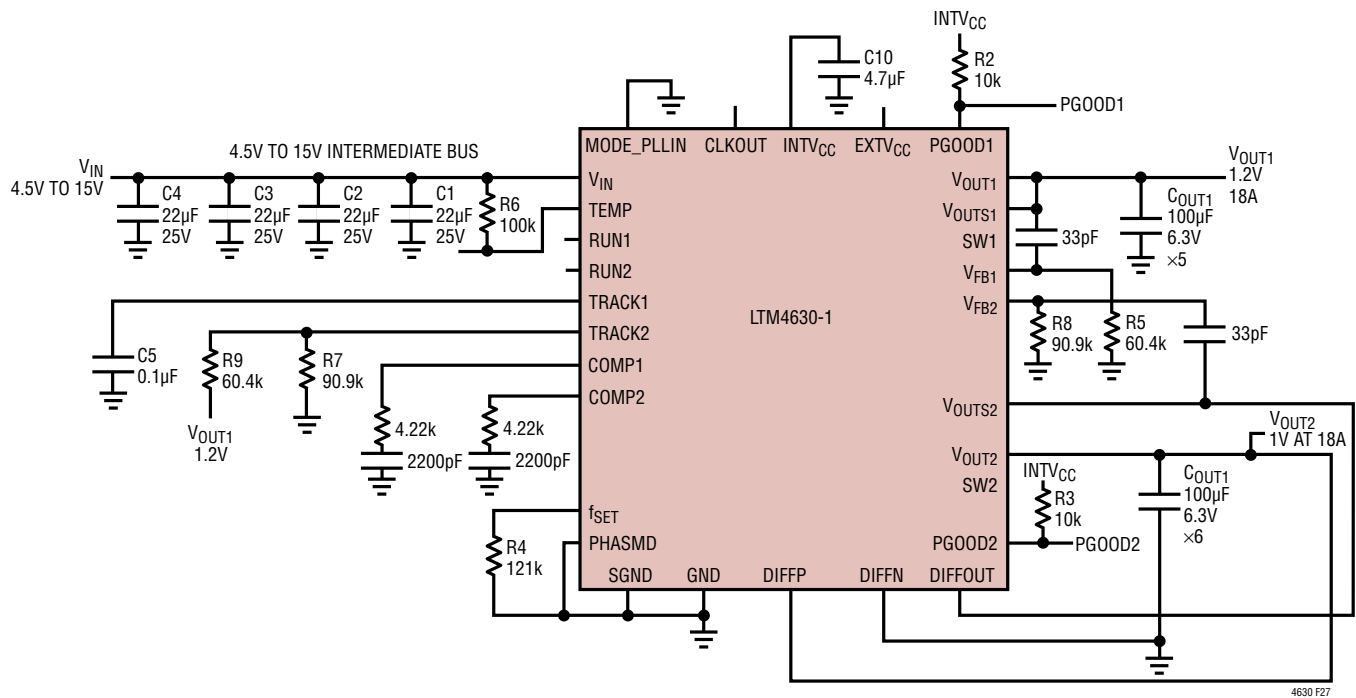

Figure 27. LTM4630-1 1.2V and 1V Output with Tracking Function

## TYPICAL APPLICATIONS

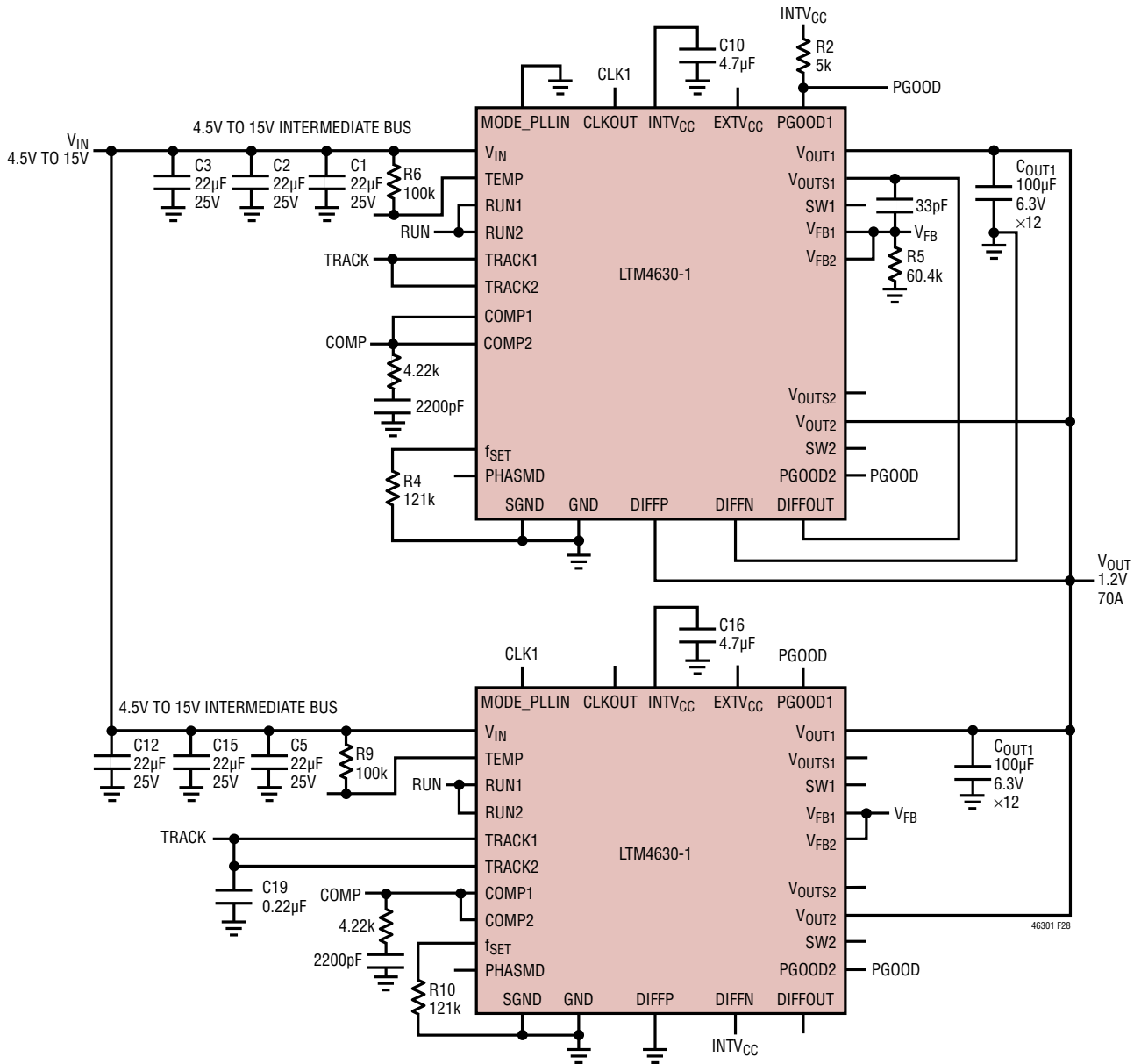

Figure 28. LTM4630-1 4-Phase, 1.2V at 70A

## PACKAGE DESCRIPTION

### LTM4630-1 Component BGA Pinout

PIN ID	FUNCTION	PIN ID	FUNCTION	PIN ID	FUNCTION	PIN ID	FUNCTION	PIN ID	FUNCTION	PIN ID	FUNCTION
A1	V <sub>OUT1</sub>	B1	V <sub>OUT1</sub>	C1	V <sub>OUT1</sub>	D1	GND	E1	GND	F1	GND
A2	V <sub>OUT1</sub>	B2	V <sub>OUT1</sub>	C2	V <sub>OUT1</sub>	D2	GND	E2	GND	F2	GND
A3	V <sub>OUT1</sub>	B3	V <sub>OUT1</sub>	C3	V <sub>OUT1</sub>	D3	GND	E3	GND	F3	GND
A4	V <sub>OUT1</sub>	B4	V <sub>OUT1</sub>	C4	V <sub>OUT1</sub>	D4	GND	E4	GND	F4	MODE_PLLIN
A5	V <sub>OUT1</sub>	B5	V <sub>OUT1</sub>	C5	V <sub>OUT1S</sub>	D5	V <sub>FB1</sub>	E5	TRACK1	F5	RUN1
A6	GND	B6	GND	C6	f <sub>SET</sub>	D6	SGND	E6	COMP1	F6	SGND
A7	GND	B7	GND	C7	SGND	D7	V <sub>FB2</sub>	E7	COMP2	F7	SGND
A8	V <sub>OUT2</sub>	B8	V <sub>OUT2</sub>	C8	V <sub>OUT2S</sub>	D8	TRACK2	E8	DIFFP	F8	DIFFOUT
A9	V <sub>OUT2</sub>	B9	V <sub>OUT2</sub>	C9	V <sub>OUT2</sub>	D9	GND	E9	DIFFN	F9	RUN2
A10	V <sub>OUT2</sub>	B10	V <sub>OUT2</sub>	C10	V <sub>OUT2</sub>	D10	GND	E10	GND	F10	GND
A11	V <sub>OUT2</sub>	B11	V <sub>OUT2</sub>	C11	V <sub>OUT2</sub>	D11	GND	E11	GND	F11	GND
A12	V <sub>OUT2</sub>	B12	V <sub>OUT2</sub>	C12	V <sub>OUT2</sub>	D12	GND	E12	GND	F12	GND

PIN ID	FUNCTION	PIN ID	FUNCTION	PIN ID	FUNCTION	PIN ID	FUNCTION	PIN ID	FUNCTION	PIN ID	FUNCTION
G1	GND	H1	GND	J1	GND	K1	GND	L1	GND	M1	GND
G2	SW1	H2	GND	J2	V <sub>IN</sub>	K2	V <sub>IN</sub>	L2	V <sub>IN</sub>	M2	V <sub>IN</sub>
G3	GND	H3	GND	J3	V <sub>IN</sub>	K3	V <sub>IN</sub>	L3	V <sub>IN</sub>	M3	V <sub>IN</sub>
G4	PHASEMD	H4	GND	J4	V <sub>IN</sub>	K4	V <sub>IN</sub>	L4	V <sub>IN</sub>	M4	V <sub>IN</sub>
G5	CLKOUT	H5	GND	J5	GND	K5	GND	L5	V <sub>IN</sub>	M5	V <sub>IN</sub>
G6	SGND	H6	GND	J6	TEMP	K6	GND	L6	V <sub>IN</sub>	M6	V <sub>IN</sub>
G7	SGND	H7	GND	J7	EXTV <sub>CC</sub>	K7	GND	L7	V <sub>IN</sub>	M7	V <sub>IN</sub>
G8	PGOOD2	H8	INTV <sub>CC</sub>	J8	GND	K8	GND	L8	V <sub>IN</sub>	M8	V <sub>IN</sub>
G9	PGOOD1	H9	GND	J9	V <sub>IN</sub>	K9	V <sub>IN</sub>	L9	V <sub>IN</sub>	M9	V <sub>IN</sub>
G10	GND	H10	GND	J10	V <sub>IN</sub>	K10	V <sub>IN</sub>	L10	V <sub>IN</sub>	M10	V <sub>IN</sub>
G11	SW2	H11	GND	J11	V <sub>IN</sub>	K11	V <sub>IN</sub>	L11	V <sub>IN</sub>	M11	V <sub>IN</sub>
G12	GND	H12	GND	J12	GND	K12	GND	L12	GND	M12	GND

## PACKAGE DESCRIPTION

**BGA Package**  
**144-Lead (16mm × 16mm × 5.01mm)**  
 (Reference LTC DWG # 05-08-1969 Rev A)

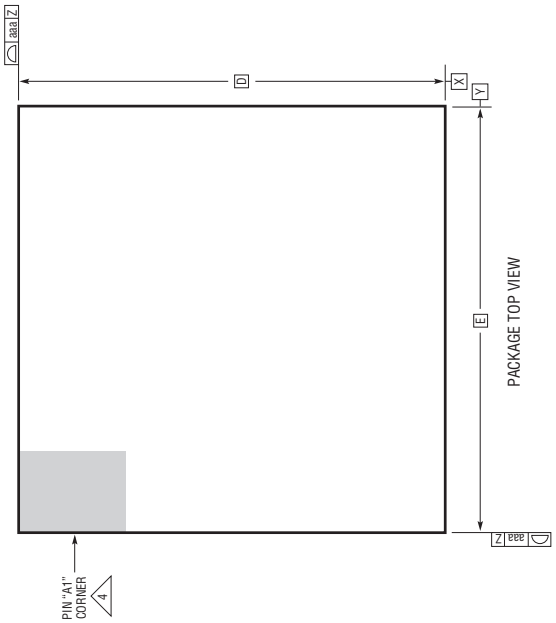
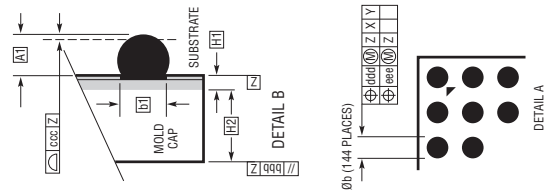
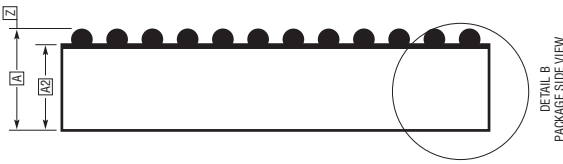
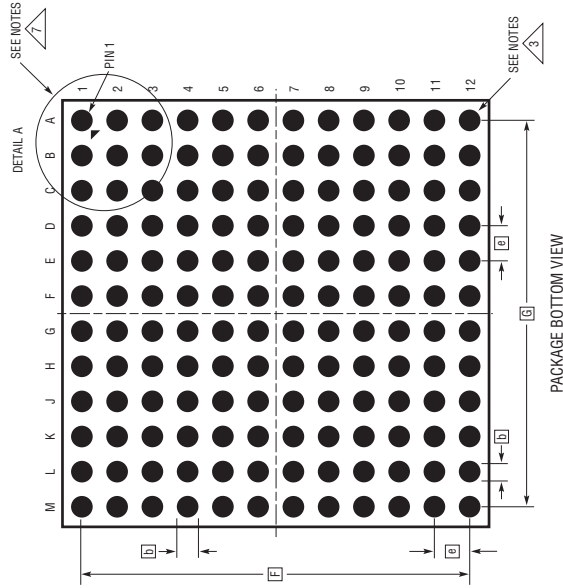

- NOTES:**
1. DIMENSIONING AND TOLERANCING PER ASME Y14.5M-1994
  2. ALL DIMENSIONS ARE IN MILLIMETERS. DRAWING NOT TO SCALE
  3. BALL DESIGNATION PER JEDEC MS-028 AND JEP95
  4. DETAILS OF PIN #1 IDENTIFIER ARE OPTIONAL, BUT MUST BE LOCATED WITHIN THE ZONE INDICATED. THE PIN #1 IDENTIFIER MAY BE EITHER A MOLD OR MARKED FEATURE
  5. PRIMARY DATUM -Z- IS SEATING PLANE
  6. SOLDER BALL COMPOSITION CAN BE 96.5% Sn/3.0% Ag/0.5% Cu OR Sn/Pb EUTECTIC
  7. PACKAGE ROW AND COLUMN LABELING MAY VARY AMONG µModule PRODUCTS. REVIEW EACH PACKAGE LAYOUT CAREFULLY

DIMENSIONS		MIN	NOM	MAX	NOTES
A		4.81	5.01	5.21	
A1		0.50	0.60	0.70	BALL HT
A2		4.31	4.41	4.51	
b		0.60	0.75	0.90	BALL DIMENSION
b1		0.60	0.63	0.66	PAD DIMENSION
D			16.00		
E			16.00		
e			1.27		
F			13.97		
G					
H1		0.36	0.41	0.46	SUBSTRATE THK
H2		3.95	4.00	4.05	MOLD CAP HT
aaa				0.15	
bbb				0.10	
ccc				0.20	
ddd				0.30	
eee				0.15	
					TOTAL NUMBER OF BALLS: 144

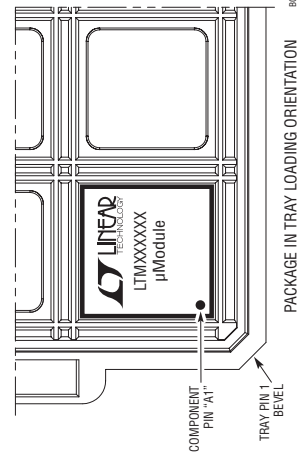
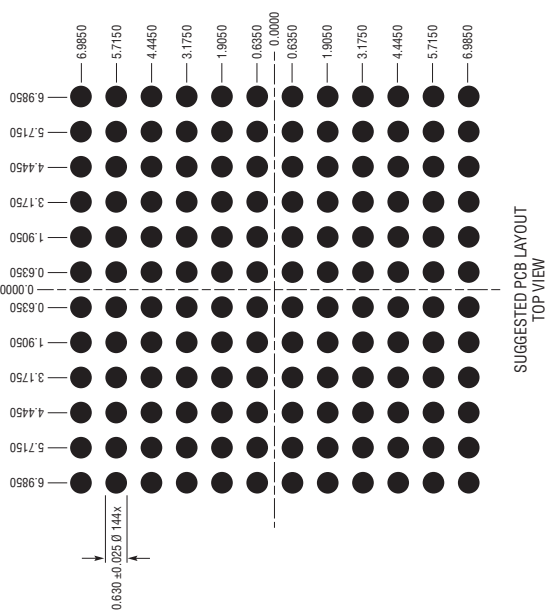

## REVISION HISTORY

REV	DATE	DESCRIPTION	PAGE NUMBER
A	08/15	Figure 3: Changed 2500 to 2600 for 1.2% Total DC Accuracy.	12
B	12/16	Updated efficiency graph. Added Note 8. Updated thermal image. Updated text to match updated efficiency and thermal data. Updated $\theta_{JA}$ on Table 2 and Table 3. Updated power loss curve and derating curve.	1, 6 3, 5 24 24, 25 26 29, 30
C	1/24	Updated Finish Code on Order Information table from e4 to e1, deleted Total DC Accuracy column SYNC capture range updated to 750kHz. Changed master to main and slave to subordinate.	2 3, 11, 15, 17 All

## PACKAGE PHOTOS Part marking is either ink mark or laser mark

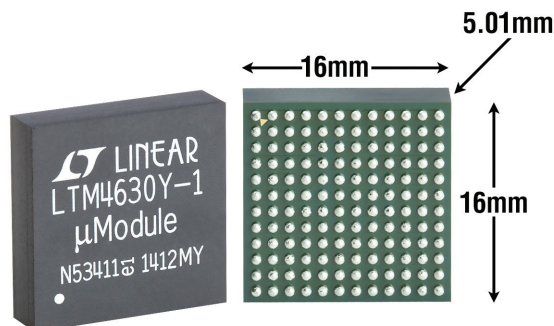

## DESIGN RESOURCES

SUBJECT	DESCRIPTION
<a href="#">μModule Design and Manufacturing Resources</a>	<p><b>Design:</b></p> <ul style="list-style-type: none"> <li>• Selector Guides</li> <li>• Demo Boards and Gerber Files</li> <li>• Free Simulation Tools</li> </ul> <p><b>Manufacturing:</b></p> <ul style="list-style-type: none"> <li>• Quick Start Guide</li> <li>• PCB Design, Assembly and Manufacturing Guidelines</li> <li>• Package and Board Level Reliability</li> </ul>
<a href="#">μModule Regulator Products Search</a>	<ol style="list-style-type: none"> <li>1. Sort table of products by parameters and download the result as a spread sheet.</li> <li>2. Search using the Quick Power Search parametric table.</li> </ol> <div style="border: 1px solid #ccc; padding: 5px; margin-top: 10px;"> <p><b>Quick Power Search</b></p> <p>INPUT   <math>V_{in}(Min)</math> <input type="text"/> V      <math>V_{in}(Max)</math> <input type="text"/> V</p> <p>OUTPUT   <math>V_{out}</math> <input type="text"/> V      <math>I_{out}</math> <input type="text"/> A</p> <p>FEATURES   <input type="checkbox"/> Low EMI    <input type="checkbox"/> Ultrathin    <input type="checkbox"/> Internal Heat Sink</p> <p style="text-align: right;"><a href="#">Multiple Outputs</a>      <a href="#">Search</a></p> </div>
<a href="#">Digital Power System Management</a>	Analog Devices' family of digital power supply management ICs are highly integrated solutions that offer essential functions, including power supply monitoring, supervision, margining and sequencing, and feature EEPROM for storing user configurations and fault logging.

## RELATED PARTS

PART NUMBER	DESCRIPTION	COMMENTS
<a href="#">LTM4620</a>	Lower Current of the LTM4630, Dual 13A or Single 26A	$4.5V \leq V_{IN} \leq 16V$ , $0.6V \leq V_{OUT} \leq 2.5V$ , 15mm × 15mm × 4.41mm (BGA), 15mm × 15mm × 5.01mm (BGA)
<a href="#">LTM4630</a>	Internal Compensation of the LTM4630-1	$4.5V \leq V_{IN} \leq 15V$ , $0.6V \leq V_{OUT} \leq 1.8V$ , 16mm × 16mm × 4.41mm (LGA), 16mm × 16mm × 5.01mm (BGA)
<a href="#">LTM4630A</a>	Higher $V_{OUT}$ of the LTM4630, $V_{OUT} \leq 8V$	$4.5V \leq V_{IN} \leq 15V$ , $0.6V \leq V_{OUT} \leq 8V$ , 16mm × 16mm × 4.41mm (LGA), 16mm × 16mm × 5.01mm (BGA)
<a href="#">LTM4650</a>	Higher Current of the LTM4630, Dual 25A or Single 50A	$4.5V \leq V_{IN} \leq 15V$ , $0.6V \leq V_{OUT} \leq 1.8V$ , 16mm × 16mm × 5.01mm (BGA)
<a href="#">LTM4650-1</a>	Higher Current of the LTM4630-1, Dual 25A or Single 50A	Pin Compatible with LTM4630-1, $4.5V \leq V_{IN} \leq 15V$ , $0.6V \leq V_{OUT} \leq 1.8V$ , 16mm × 16mm × 5.01mm (BGA)
<a href="#">LTM4631</a>	Ultrathin, Lower Current of the LTM4630, Dual 10A or Single 20A, 1.91mm Package Height	$4.5V \leq V_{IN} \leq 15V$ , $0.6V \leq V_{OUT} \leq 1.8V$ , 16mm × 16mm × 1.91mm (LGA)
<a href="#">LTM4636</a>	Single 40A μModule Regulator with Excellent Thermal Performance	$4.7V \leq V_{IN} \leq 15V$ , $0.6V \leq V_{OUT} \leq 3.3V$ , 16mm × 16mm × 7.07mm BGA Package
<a href="#">LTM4647</a>	Single 30A μModule Regulator in Small Package	$4.7V \leq V_{IN} \leq 15V$ , $0.6V \leq V_{OUT} \leq 1.8V$ , 9mm × 15mm × 5.01mm BGA Package
<a href="#">LTM4677</a>	LTM4630 with PSM Function	$4.5V \leq V_{IN} \leq 16V$ , $0.5V \leq V_{OUT} \leq 1.8V$ , 16mm × 16mm × 5.01mm (BGA)

Rev. C